

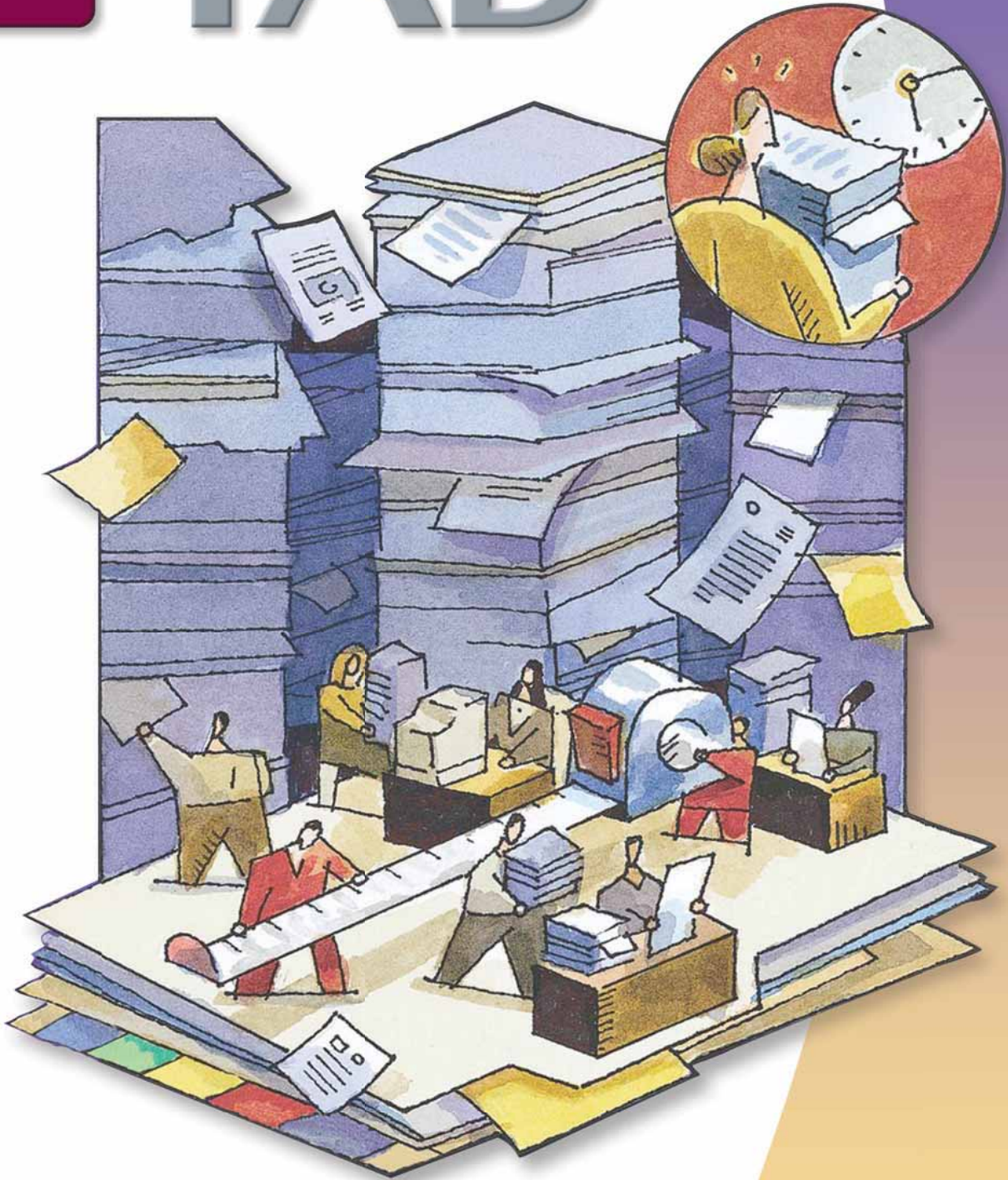

TAB



Filing Systems & Supplies

SPECIFICATION GUIDE

www.tab.com



Terms and Conditions

Terms: Net 30, FOB ship point with freight prepaid by TAB and added to the invoice. Call customer service for shipping options and prices. Payment terms and remit to addresses are stated on invoice.

Minimum Order Value: If the value of product(s) to ship from TAB's warehouse is less than \$25.00, an up-charge will be added to raise that total order value not including tax and freight to \$25.00.

Minimum Order Quantity: Select custom products have minimum order quantities.

Split Box Shipments: Products are listed with box and carton quantities. Orders for less than a full box will automatically be increased to the next full box quantity and the price will be increased accordingly.

Returns: Absolute Guarantee allows you to return any stock product that does not meet your expectations, within 90 days, for any reason. All returns must be pre-approved by Customer Service. Stock models are returnable with pre-authorization and assessed a restocking fee. Return freight is the customer's responsibility. Custom products may not be returned.

Cancellations: All cancellations must be pre-approved by Customer Service. Stock product orders may be cancelled prior to shipment without a cancellation charge. Cancellation of custom made products will result in cancellation charges if special materials have been procured or manufacturing has begun.

Product Offering & Prices: TAB reserves the right to change product specifications. Prices are subject to change without prior notice.

- TAB reserves the right to correct typographical errors at any time.
- Colors represented in this catalog are as close as possible to actual TAB product colors within the limits of modern graphic processes.

Welcome to the World of TAB

As the leading provider of professional color-coded filing systems and supplies, we pass on the benefits of more than 55 years of practical experience. We understand that your information is one of the most valuable assets in your organization. We also understand that efficiency and profit suffer when files are unavailable, misplaced or lost.

TAB is devoted to keeping you efficient. That's what this catalog is all about. It doesn't matter whether your needs are large or small, simple or complex. Behind every catalog there's a TAB representative as near as your phone. Your TAB filing specialist is ready to consult with you and develop filing, storage, retrieval and workflow systems that can include everything from simple folders and labels to sophisticated automated tracking and labeling.

TAB offers standard and custom-designed filing supplies. Our company's headquarters, including manufacturing and distribution facilities are centrally located in South Eastern Wisconsin, providing efficient national service.

Recycled Content:

- 11, 14, and 18 Pt. Manila 10% Consumer Material (PCM).
- 11 & 14 Pt. Color 20% PCM.
- 11 & 17 Pt. Kraft 10% PCM.
- Pressboard:
 - Type I 50% Recycled, 30% PCM.
 - Type II 70% Recycled 25% PCM.
 - Type III 50% Recycled, 20% PCM.

Custom Products: TAB specializes in making custom folders and pockets. Most custom folders can be priced by referring to the Value Added Stock Products section in this guide. If the desired product is not in our catalog call us at 800-827-3288 for assistance and press option 3, or email csquotes@tab.com for our Paper and Supplies Customer Service.

Over Runs or Under Runs: We attempt to ship exact quantities as ordered; however, we reserve the right to over-ship or under-ship a maximum of 5% on custom manufactured or printed items. On custom folders requiring color-coding the exact quantity of color-coded labels will be applied which frequently results in left over custom folders. These excess folders will have blank matrix labels attached and shipped. Billing will reflect the quantity produced and shipped.

TABQUIK®, CompuColor®, FilePak®, AlphaCode®, TABSTIK®, Designer Series®, SIDE-TRAC®, FORTIfile®, and Datafile® are Registered Trademarks of TAB Products Co, LLC. Genuine Pressboard Type I® and II® are Registered Trademarks of FibreMark, Inc. Tyvek® is registered trademark for DuPonts spunbonded olefin.

Ames®, Smead®, Barkley®, Jeter®, AFV®, Mailwell®, Colorflex®, Colorbar®, GBS®, and Semco® are all trademarks owned by their respective companies. They are used in this catalog to identify compatibility purposes only.



**Contact Our
Customer Service
Department Today!**

1-888-822-9777



Table of Contents

General Information

Professional Services	4
How to Choose the Right Filing Systems	5
Customize Your Folder	6
Our Top 8 Custom Folders.....	7
Anatomy of a TAB Folder	8
New at TAB	35
Index	47

TAB Folders

Manila Folders.....	9
Color Folders	10
Color Stripe Folders.....	10
Pressboard Expansion Folders.....	12
Pressboard Classification Folders.....	14
Top TAB Folders.....	32
FortiFile®.....	34

TAB Pockets

Manila Flat Pockets.....	11
Color Stripe Flat Pockets.....	11
Color Flat Pockets	11
Expansion Pockets	16
Medical X-ray Jackets.....	36

Indexes

Custom Indexes.....	18
---------------------	----

Custom Options

Fasteners	20
Pockets.....	21
Printing	21
Dividers	22
Convert-a-Tab	23
File Backs.....	23
Cov'r Tabs.....	23

TAB Labels

Alphabetic Labels	24
Numeric Labels	26
Solid Classification Labels	27
TABQUIK® Labels.....	28
Year Labels.....	30
Month Labels	30
Barcode Labels	30
Label Protectors	30
Label Organizer Boxes	30
Top TAB Labels.....	33

Guides

Vinyl Out Guides.....	31
Colorvue Guides	31
Top TAB Guides	33

Storage Boxes

Storage/Transfer Boxes.....	36
-----------------------------	----

Companion Products

Datafile® Folders.....	39
Datafile® Pockets.....	39
Datafile® Alphabetic Labels.....	40
Datafile® Numeric Labels.....	41
Medical Labels	42
Barkley® Competitive Match Labels	43
Jeter® Competitive Match Labels	44
Smead® Competitive Match Labels	45
Ames® Competitive Match Labels	46



We didn't know you did that!

When you use TAB's professional services group, you gain TAB's intellectual capital and add the expertise of staffing resources to achieve your corporate objectives. Before you begin the project, you know the cost and insure the quality of the outcome with our proven methodologies, industry specialized resources, guaranteed time commitment and dedicated staff. Best of all, we not only have nationwide coverage, but international scope to provide for your projects whether they're in Fort Wayne, Toronto or even London.



TAB'S PROFESSIONAL SERVICES

WHAT?

- Retention Scheduling
- Box Inventory
- Records Inventories
- Imaging Strategy
- RM Program Design/ Implementation
- RM Software Design/ Implementation
- Records Moves
- File Conversions
- Acquisition Integration
- Divestiture
- Imaging Services
- Data Capture
- Retention Schedule Implementation
- Bar Coding
- File Room Management

WHEN?

- Merger
- Acquisition
- Compliance
- Litigation
- Certification
- Audit
- Downsizing
- Restacking
- Growing
- Relocating
- Additional Corporate Initiatives

WHY?

- Solve A Business Problem
- Improve Business Processes
- Manage Risk
- Turn-Key Solution
- Add to Core Competency
- Enhance Internal Resources
- Focus on Core Business Functions.

How to Choose the Right Filing Systems



Organizations face unique challenges that demand unique solutions. TAB can help analyze, plan and implement custom records management solutions to meet your needs. An effectively designed records management program is an essential tool to enhance responsiveness, increase customer satisfaction, ensure compliance with industry regulations and improve access to information.

TAB offers custom tiered solutions to match your exact needs. We provide color-coded filing systems, high-density mobile and shelving, records management consulting and file room outsourcing services.

Folders 101: Choosing the right folder for your filing needs

Did you know that the folder is the most fundamental element of record management? It has three basic purposes:

- House and Identify documents
- Support and Protect documents
- Align Labels with each other for Locating desired documents

Choosing the right folder for your record management needs can seem like a daunting task, but TAB can provide you with the basics to help make your choice as simple as possible.

Folder Storage Capacity

What size documents will you be storing?

Are you storing many pages together, or heavier documents?

Will there be any odd size documents that need to be stored within the file (i.e. Photos, disks)?

How often will you be using these documents/folders?

Are you using open lateral files or pull drawer vertical files?

Does the information in your folders need to be segmented into different groups?

These are all important questions that help determine the type of material your folder should be made from, as well as how much expansion you will need in that folder, what accessories might be helpful, or what type of tab configuration you will need.

Folder Material

Folders are manufactured in a variety of paper stocks and thicknesses (point categories). The paper stocks include Manila, Color, Pressboard and Red Wallet/Red Rope. They can range in thickness options from 11 to 28 point with the greater the point, the more durable the paper stock.

The most popular paper stock is **Manila**. It comes in 11, 14 and 18-point thickness and is best for light to moderate use. Some of the reasons it is so popular is because it can be written or printed on and is smudge resistant. It is smooth and resists tearing, folding or bursting.

Color paper stock, available in a variety of colors and comes in 11 or 14 point. It is also best for light to moderate use. Color folders help speed up filing and retrieval time in any system and are ideal for designating special records. Alternatives are manila folders with color end tabs called Color Stripe folders.



Pressboard is one of the most durable materials in the industry. Type I is a high density, 20-point premium stock that is actually thinner, but more durable – and it is available in 16 colors. Type II is a medium density, 25-point pressboard stock and is the industry standard for commercial or classification folders. It comes in Green/Gray color only.



Red Wallet or Red Rope stock is used for Expansion Pockets. It primarily comes in 22-point thickness, with a few 28-point options available as well. This is a very durable material, which is combined with Tyvek® Tape on the gusset expansion of the file to make it virtually indestructible. This stock is available in its well-known brownish red color, or in eleven other colors.



Accessories

Printing is primarily used to help identify the record inside the folder. The most popular place for ink printing is the front cover, but printing can be done on any panel and can be done in black ink or any other color.

Although documents can be filed “loose leaf” within a folder, another method of housing papers can be to use a fastener. **Fasteners** have several benefits. They ensure that the documents will not be mixed easily with other records and they allow the information to be attached in an organized manner in its protective cover. Fastener

styles vary and can be put in any of eight positions within a folder.

Pockets eliminate filing time for odd-sized items. Accessing these items requires minimal filing time because the documents are not attached to the folder, but are held securely in place by the pocket. They come in two types – Factory Installed Manila Pockets or Transparent Poly/Vinyl Self Adhesive Pockets and in several sizes. The pockets can be put in any of the same eight positions as fasteners.

To keep information in organized groups within your folder, you can use **Dividers**. These can come with or without fasteners installed in the dividers and can be factory installed or self-installed.

Color-coding is a system in which colors are assigned to represent letters and/or numbers to create color block patterns that are visually easy to scan. TAB offers several color-coded solutions.

Self-Adhesive Hand Wrap Labels are printed with inks and coated with adhesives that last a lifetime. They come in Alphabetic, Numeric or Solid Color styles and are ½” or 1” in size. Ideal for small office applications or as an over-wrap for re-using existing folders. These labels are efficient and economical.

Factory Attached Strip Labels are single strip labels that are printed from computer data. They have unlimited options such as any color palette, lines of cross reference, highlighting, font options, even customizable with a company logo! TAB can even provide labels on a daily basis. Once we receive your data, we generate your new color-coded folders, and deliver your customized folders within 3-5 business days from when the records were transmitted.

ORGANIZE. ACCESS. MANAGE.

Better organized files and documents. Quicker access to information. Lower costs. Reduced exposure to risk. These are the benefits of choosing TAB as your records management partner.





Custom Folders

Customize Your Folder

Built to Suit Your Needs

TAB will customize your folder to suit whatever need you may have. Or, build it yourself with any of our "Do-It-Yourself" accessories.

Printing (Page 21)

Outside Front, Inside Front, Inside Back, Outside Back. 500 or 100,000. One Color. Two colors. Your artwork. Our artwork. Tab can print whatever you want wherever you want it.

Pockets (Page 21)

Want to keep small items from falling out of your file? Add a manila pocket in one or several locations. From credit cards to letter size documents these factory installed pockets can improve your information process.

Color Coding (Page 24)

Color Coding Labels improve all your filing activities in file and out of file. Coding the filing format increases the speed of filing and locating information and eliminate misfiles. Coding dates separates active from inactive files, Coding file groups alerts users to appropriate actions.

Dividers (Page 22)

Keep information in organized groups within your folder with installed dividers. Optional twin prong fastener allows for attaching documents on either side of the divider.

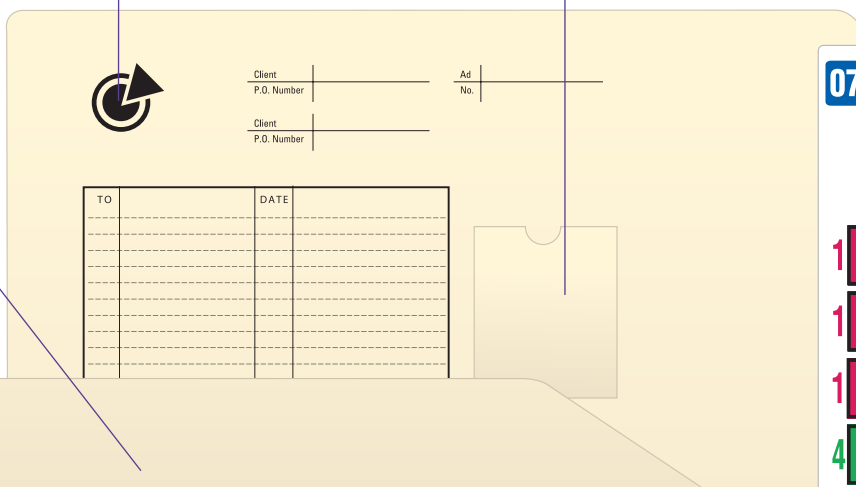

Fasteners (Page 20)

Need to permanently attach documents to your folder? Use these fasteners to convert your plain manila folder to a fastener folder quickly and permanently! From a simple self adhesive fastener, to a twin prong, or use a Docuclip fastener. Docuclips permit you to save time allowing you to interfile without removing pages.

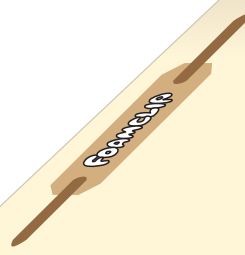



Our Top 8 Custom Folders

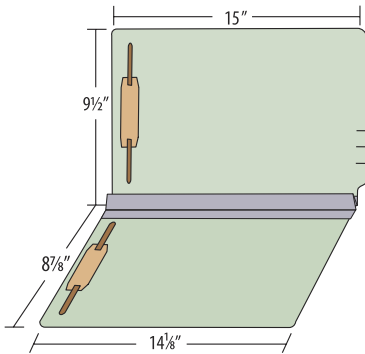

Model
1351-00 B13

Green/Grey Pressboard 2" Expansion Folder - 25pt. 2 Tab, Legal with 2" Bonded Fasteners in Positions 1 & 3

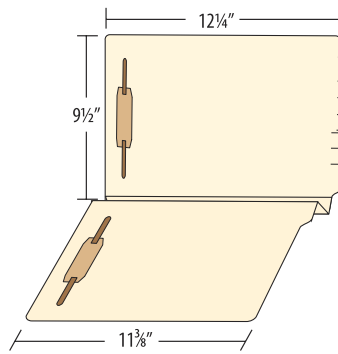

Model
1196-00 B13

Manila Folder with 1 1/2" Expansion, Single Ply Side Tab - 18pt. Standard, Letter with 2" Bonded fasteners in Positions 1 & 3

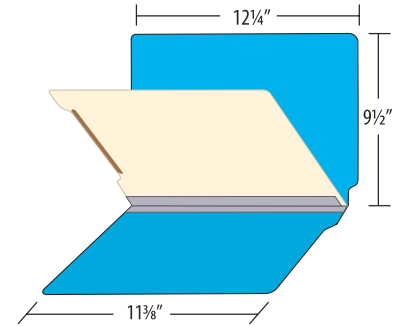

Model
1106-02 N5

Color Folder Double-Ply Side Tab - 11pt., Standard Letter with 1 Divider

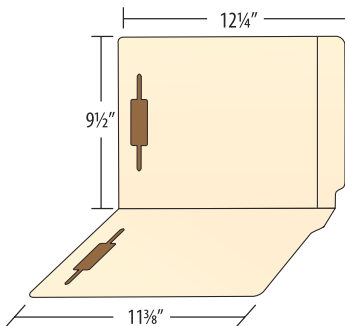

Model
1103-50 B13

Manila Folder, Double Ply Side Tab - 11pt. Standard, Letter with 2" Bonded Fasteners in Positions 1 & 3

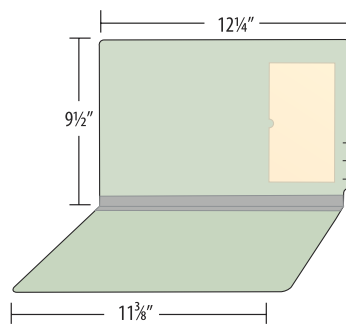

Model
1235-00 J2

Green/Grey Pressboard 1" Expansion Folder - 25 pt. Side Tab, Letter with Pocket in Position 2

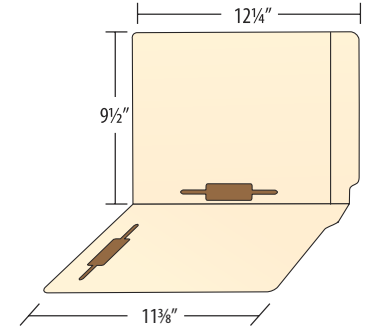

Model
1103-50 B35

Manila Folder, Double Ply Side Tab - 11pt. Standard, Letter with 2" Bonded Fasteners in Positions 3 & 5

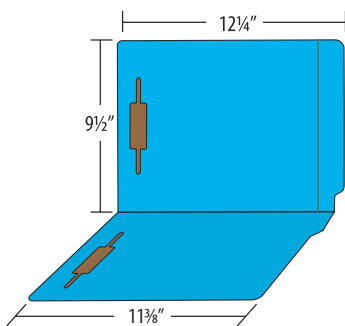

Model
1106-02 B13

Color Folder, Double Ply Side Tab - 11pt. Standard, Letter with 2" Bonded Fasteners in Positions 1 & 3

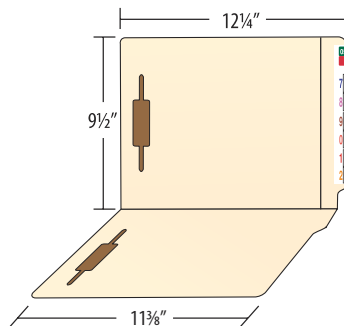

Model
1123-00 B13T

Manila Folder, Double Ply Side Tab - 14pt. Standard, Letter with 2" Bonded Fasteners in Positions 1 & 3 and Filepak Label Attached to the Side Tab

Design Your Own

- Choose a Folder or Pocket
- Choose Fastener(s) and Fastener Position(s)
- Choose Pocket(s) and Pocket Position(s)
- Choose Dividers
- Choose Printing and Printing Location
- Choose Label(s)

Any of these options can be used to customize to your specifications. See pages 20-22 or call Customer Service for details.



Anatomy of a TAB Folder

More than meets the eye

TAB has been devoted to the creation and development of the most advanced and functional folders for over 50 years. We have spent years researching filing systems around the world. We feel the TAB folder is simply the very best available anywhere.

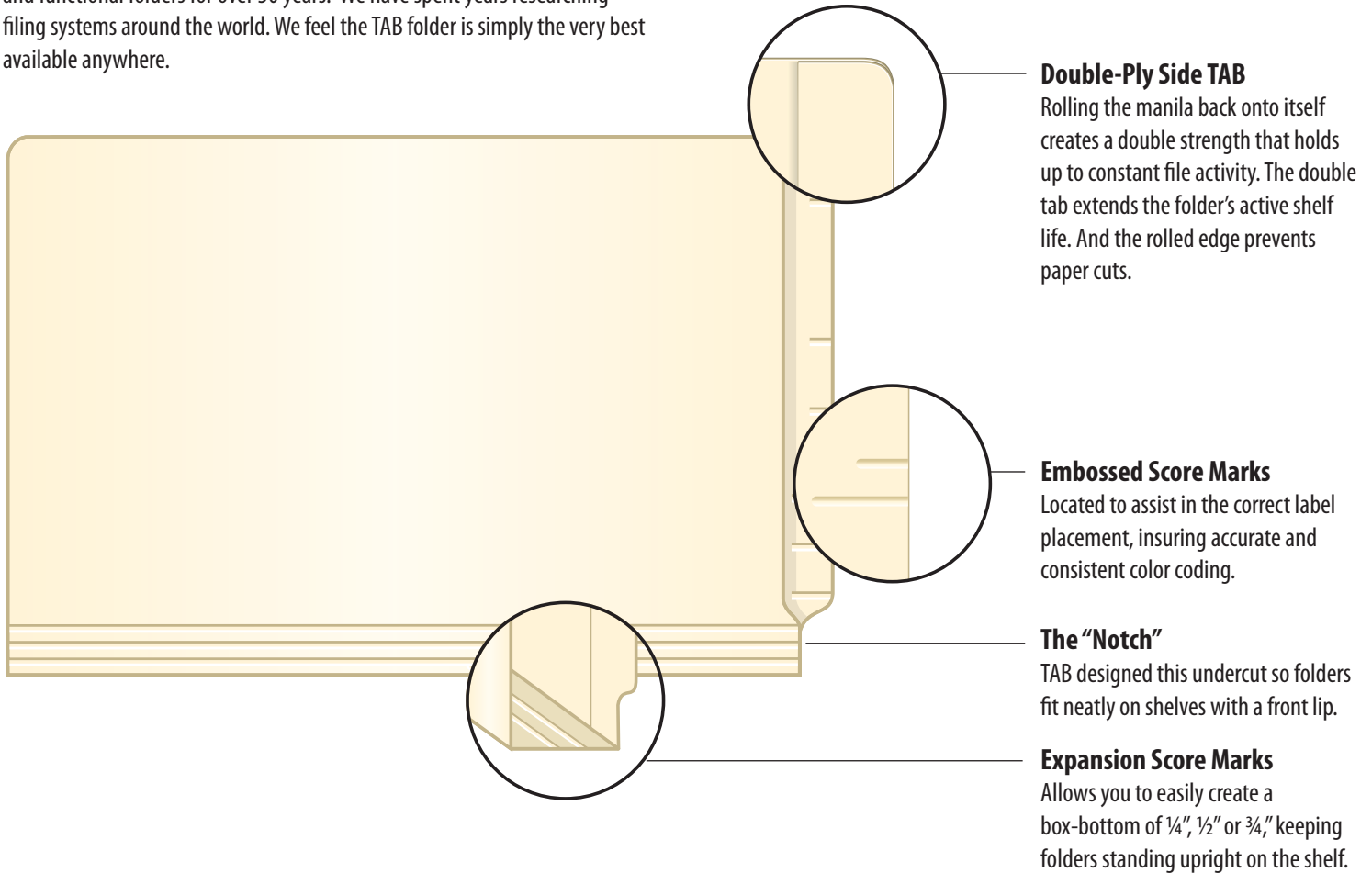

Available in:
11 pt. Manila
14 pt. Manila
18 pt. Manila



Available in:
11 pt. Color Stock
14 pt. Color Stock



Available in:
11 pt. Manila w/Colorstripe

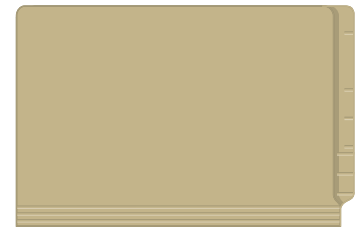

Available in:
17 pt. Kraft



Manila Folders

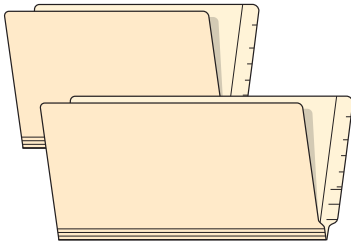

Standard

TAB's standard folders are designed to provide an inch of space in both paper dimensions insuring that your important documents are protected from wear and tear in file or out. The double-ply side tab provides extra strength where other folders often break down.

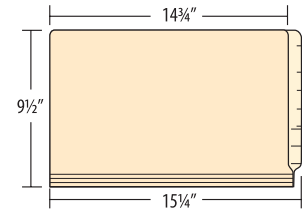
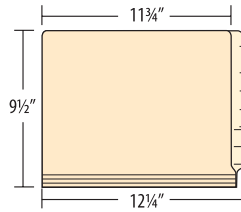

Letter

Model	Description	Carton Wt.	Packed Box/Carton
1103-50	11 pt. Double Ply	44 lbs.	100/500
1123-00	14 pt. Double Ply	26 lbs.	50/250
1102-00	11 pt. Single Ply	41 lbs.	100/500
1128-00	14 pt. Single Ply	23 lbs.	50/250
1141-00	18 pt. Single Ply	34 lbs.	50/250

Legal

Model	Description	Carton Wt.	Packed Box/Carton
1105-50	11 pt. Double Ply	54 lbs.	100/500
1127-00	14 pt. Double Ply	28 lbs.	50/250
1104-00	11 pt. Single Ply	50 lbs.	100/500
1118-00	14 pt. Single Ply	35 lbs.	50/250
1142-00	18 pt. Single Ply	40 lbs.	50/250

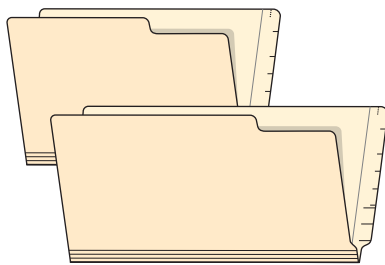

Short Body

Need to store your folders in a drawer as well as on a shelf? Our short body folder (Length reduced by 1/4") has a space provided on the top back panel to attach a label for quick identification.

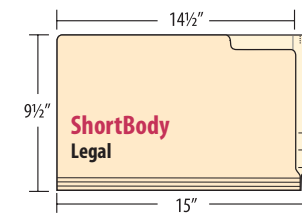
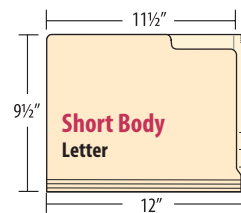

Letter

Model	Description	Carton Wt.	Packed Box/Carton
1317-00	11 pt. Double Ply	44 lbs.	100/500
1318-00	14 pt. Double Ply	56 lbs.	100/500

Legal

Model	Description	Carton Wt.	Packed Box/Carton
1327-00	11 pt. Double Ply	55 lbs.	100/500
1328-00	14 pt. Double Ply	32 lbs.	50/250

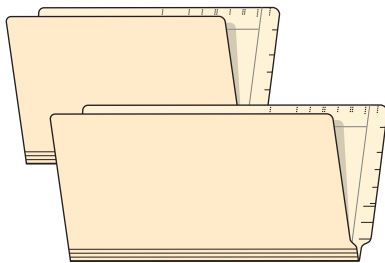

2TAB

Full length top and side tabs allow for color coding labels to be applied in both locations. And with its reduced length (1/4") it fits safely into a drawer or a shelf.

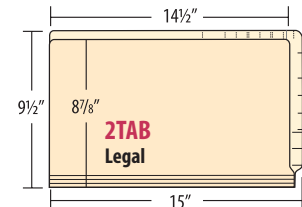
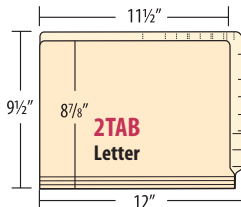

Letter

Model	Description	Carton Wt.	Packed Box/Carton
1344-00	11 pt. 2TAB	45 lbs.	100/500
1345-00	14 pt. 2TAB	27 lbs.	50/250

Legal

Model	Description	Carton Wt.	Packed Box/Carton
1346-00	11 pt. 2TAB	25 lbs.	50/250
1347-00	14 pt. 2TAB	32 lbs.	50/250

11 pt. is double-ply top and side tabs. 14 pt. is single-ply top tab and double-ply side tab.

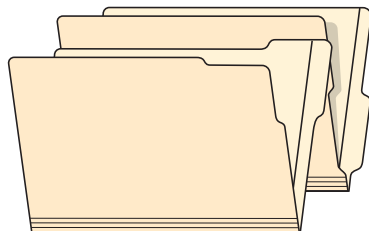

Half Cut (Lower/Upper) Manila Folders

Letter size 11 pt. manila double-ply folder with 4" side tab. Ideal application for numbering on tab.

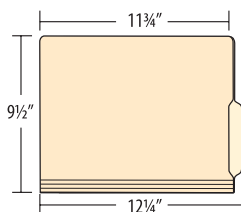

Model	Description	Carton Wt.	Packed Box/Carton
4354-50	Lower position tab	44 lbs.	100/500
4357-13	Upper position tab	44 lbs.	100/500

Looking for:

Expansion folders (1196-00/1197-00)
see page 13

Classification folders (1258-00B/1259-00B)
see page 15



TAB Folders

Color & Color Stripe Folders

Add color to your world!

Separate yourself from the crowd by using color to identify your files.

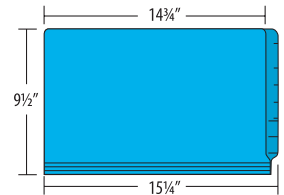
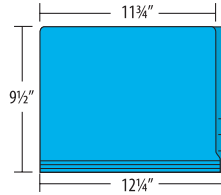
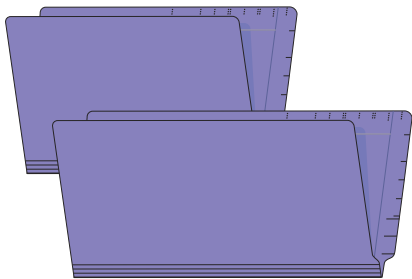
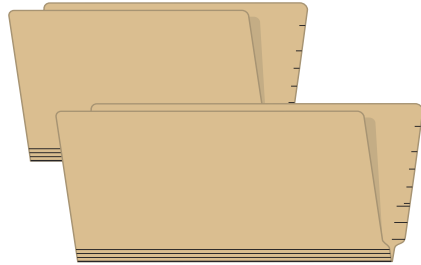
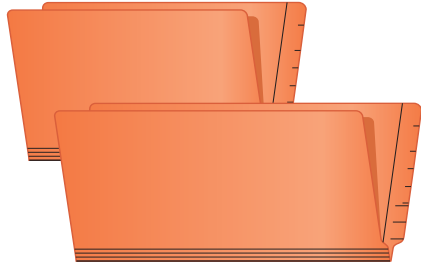

Standard Solid Color Side Tab Folders

Letter

Model	Description	Carton Wt.	Packed Box/Carton
1106-**	11 pt. Double Ply	45 lbs.	100/500
1406-**	14 pt. Double Ply	26 lbs.	50/250

Legal

Model	Description	Carton Wt.	Packed Box/Carton
1126-**	11 pt. Double Ply	56 lbs.	100/500
1426-**	14 pt. Double Ply	28 lbs.	50/250

Kraft Side Tab Folders

Letter

Model	Description	Carton Wt.	Packed Box/Carton
1129-00	17 pt. Single Ply	31 lbs.	50/250

Legal

Model	Description	Carton Wt.	Packed Box/Carton
1119-00	17 pt. Single Ply	40 lbs.	50/250

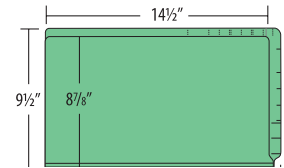
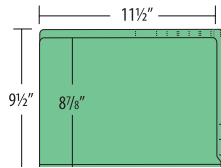

2TAB Solid Color Folders

Letter

Model	Description	Carton Wt.	Packed Box/Carton
1334-**	11 pt. 2TAB	45 lbs.	100/500
1335-**	14 pt. 2TAB	27 lbs.	50/250

Legal

Model	Description	Carton Wt.	Packed Box/Carton
1336-**	11 pt. 2TAB	25 lbs.	50/250
1337-**	14 pt. 2TAB	32 lbs.	50/250



**Choose appropriate color suffix:



11 pt. is double-ply top and side tabs. 14 pt. is single-ply top tab and double-ply side tab.

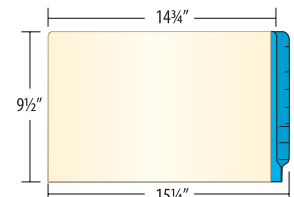
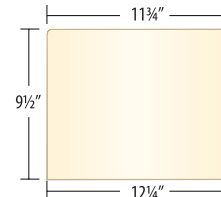

Manila Color Stripe Folders

Letter

Model	Description	Carton Wt.	Packed Box/Carton
1162-**	11 pt. Double Ply	44 lbs.	100/500

Legal

Model	Description	Carton Wt.	Packed Box/Carton
1163-**	11 pt. Double Ply	53 lbs.	100/500

**Choose appropriate color suffix:





Keep Documents Safe

With closed sides these pockets keep small items in file with larger documents. Available with two sides closed, three sides closed, manila or color side tab.

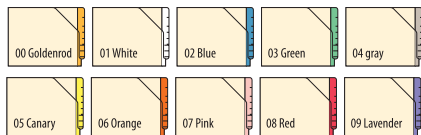
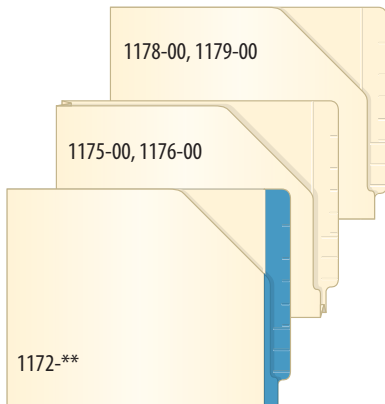

**Choose appropriate color suffix:



Manila Pockets – Closed 3 Sides

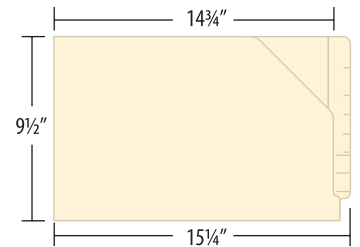
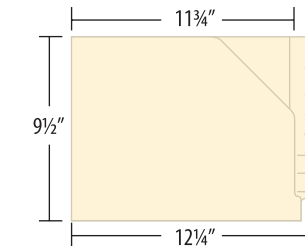

Manila Pockets – Closed 2 Sides

Letter

Model	Description	Carton Wt.	Packed Box/Carton
1178-00	11 pt Manila Flat Pocket	44 lbs.	100/500
1175-00	11 pt Manila Pocket 1 1/2" expansion	25 lbs.	50/250

Legal

Model	Description	Carton Wt.	Packed Box/Carton
1179-00	11 pt Manila Flat Pocket	26 lbs.	50/250
1176-00	11 pt Manila Pocket 1 1/2" expansion	32 lbs.	50/250

Manila Color Stripe Flat Pockets – Closed 2 Sides

Letter

Model	Description	Carton Wt.	Packed Box/Carton
1172-**	11 pt Color Stripe Flat Pocket	45 lbs.	100/500

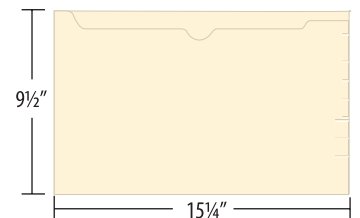
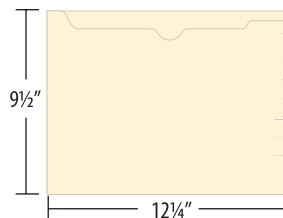

Letter

Model	Description	Carton Wt.	Packed Box/Carton
1168-00	11 pt Manila Flat Pocket	44 lbs.	100/500
1180-00	11 pt Manila Pocket 3/4" expansion	50 lbs.	100/500

Legal

Model	Description	Carton Wt.	Packed Box/Carton
1169-00	11 pt Manila Flat Pocket	27 lbs.	50/250
1181-00	11 pt Manila Pocket 3/4" expansion	32 lbs.	50/250

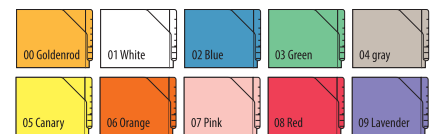
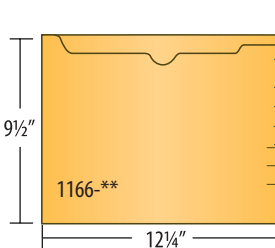
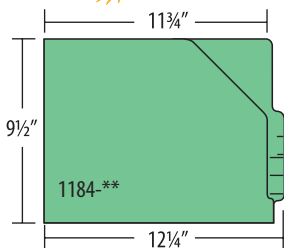
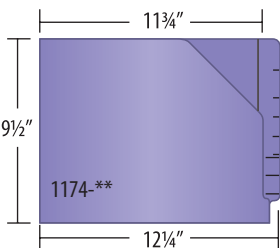

**Choose appropriate color suffix:

Color One-Piece Pockets

Letter

Model	Description	Carton Wt.	Packed Box/Carton
1174-**	11 pt Color One Piece Flat Pocket closed two sides	44 lbs.	100/500
1184-**	11 pt Color One Piece Pocket w/ 4" Lower End Tab	44 lbs.	100/500
1166-**	11 pt Color Flat Pocket closed 3 sides	44 lbs.	100/500

Full Pocket File Folder

Letter

Model	Description	Carton Wt.	Packed Box/Carton
1139-00	11 pt Manila letter size, full single ply side tab, closed 3 sides	31 lbs.	50/250

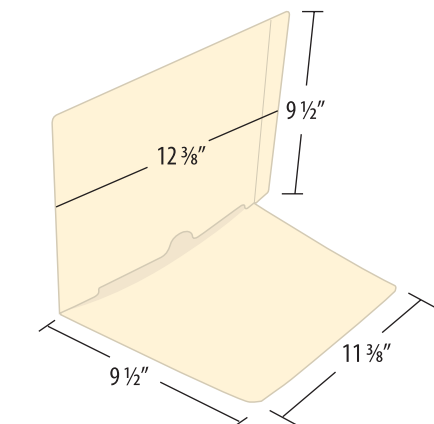



TAB Folders

Pressboard Expansion Folders

For heavy-duty filing applications

Pressboard Folders meet your system's need to provide enhanced storage of critical documents. Made of 20 pt. and 25 pt. material, with or without fasteners these folders last several lifetimes.

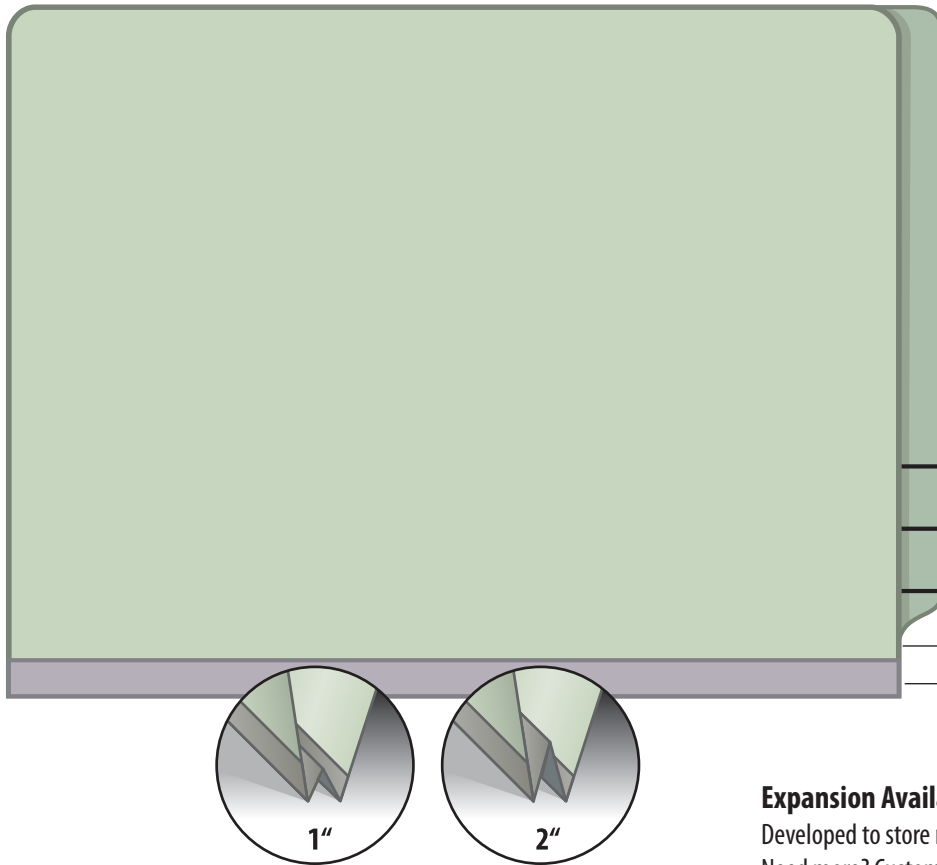

Printed Score Marks

Located to assist in the correct label placement, insuring accurate and consistent color coding.

The "Notch"

TAB designed this undercut so folders fit neatly on shelves with a front lip.

Tyvek® Tape

Virtually indestructible Tyvek connects front panel to back panel forever!

Expansion Available

Developed to store more than a normal folder, 1" and 2" expansion is standard. Need more? Custom sizes are available.

20 pt. Type I Color Pressboard

**Choose appropriate color suffix:

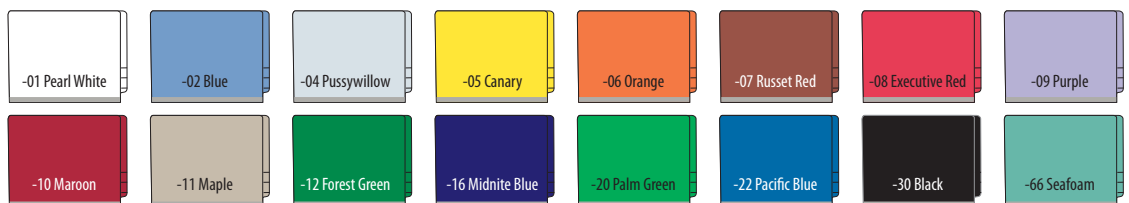

Colors -02 Blue, -05 Canary, -08 Executive Red and -20 Palm Green readily available in letter size. All other colors and any legal size color pressboard folders may require up to a 35-day lead time.

Letter

Model	Description	Carton Wt.	Packed Box/Carton
1235-**	1" Expansion Standard	32 lbs.	25/125
1236-**	2" Expansion Standard	32 lbs.	25/125
1348-**	1" Expansion 2TAB	32 lbs.	25/125
1349-**	2" Expansion 2TAB	31 lbs.	25/125

Legal

Model	Description	Carton Wt.	Packed Box/Carton
1250-**	1" Expansion Standard	32 lbs.	25/125
1251-**	2" Expansion Standard	41 lbs.	25/125
1350-**	1" Expansion 2TAB	38 lbs.	25/125
1351-**	2" Expansion 2TAB	39 lbs.	25/125

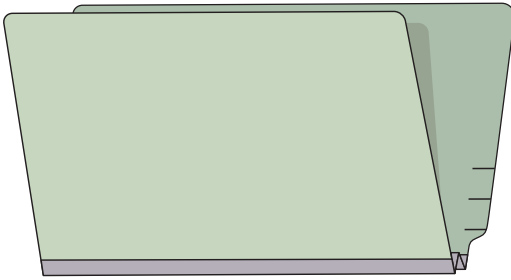

**25 pt. Type II
Green/Gray Pressboard
Standard**

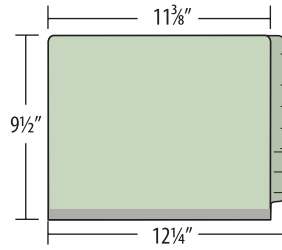

Letter

Model	Description	Carton Wt.	Packed Box/Carton
1235-00	1" Expansion Standard	30 lbs.	25/125
1236-00	2" Expansion Standard	32 lbs.	25/125

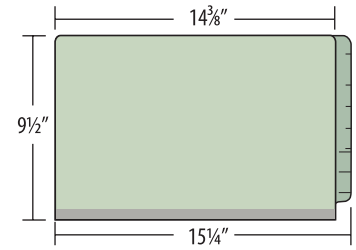

Legal

Model	Description	Carton Wt.	Packed Box/Carton
1250-00	1" Expansion Standard	40 lbs.	25/125
1251-00	2" Expansion Standard	41 lbs.	25/125

**25 pt. Type II
Green/Gray Pressboard
with 2" Bonded Fasteners**

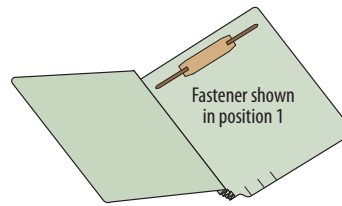

Letter

Model	Description	Carton Wt.	Packed Box/Carton
1237-00B	1" Expansion w/fasteners 1&3	33 lbs.	25/125
1238-00B	2" Expansion w/fasteners 1&3	35 lbs.	25/125
1249-00B	2" Expansion w/fasteners 1	34 lbs.	25/125

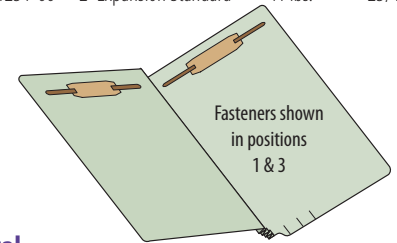

Legal

Model	Description	Carton Wt.	Packed Box/Carton
1252-00B	1" Expansion w/fasteners 1&3	40 lbs.	25/125
1253-00B	2" Expansion w/fasteners 1&3	43 lbs.	25/125



**25 pt. Type II
Green/Gray Pressboard
2TAB**

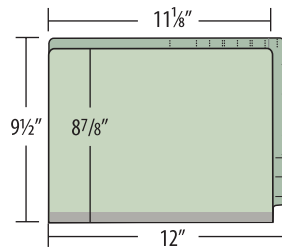

Letter

Model	Description	Carton Wt.	Packed Box/Carton
1348-00	1" Expansion 2TAB	32 lbs.	25/125
1349-00	2" Expansion 2TAB	31 lbs.	25/125

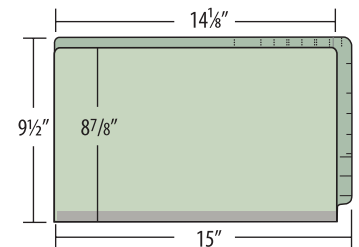

Legal

Model	Description	Carton Wt.	Packed Box/Carton
1350-00	1" Expansion 2TAB	38 lbs.	25/125
1351-00	2" Expansion 2TAB	39 lbs.	25/125

A Low-Cost Expansion Alternative

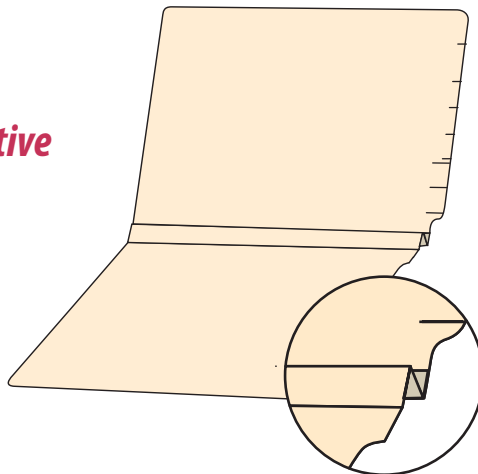

1 1/2" "W" Expansion

These sturdy 18 pt. manila folders have a paper W-fold on the bottom that expands to hold up to 1 1/2" of documents.

Model	Description	Carton Wt.	Packed Box/Carton
1196-00	Letter (9 1/2" h" x 11 3/4" w x 12 1/4" w overall)	37 lbs.	50/250
1197-00	Legal (9 1/2" h" x 14 3/4" w x 15 1/4" w overall)	48 lbs.	50/250



TAB Folders

Pressboard Classification Folders

Need to separate your files?

Classification folders allow you to divide large files into logical storage groups. Available in 20 pt Color or 25 pt Green/Gray pressboard material.

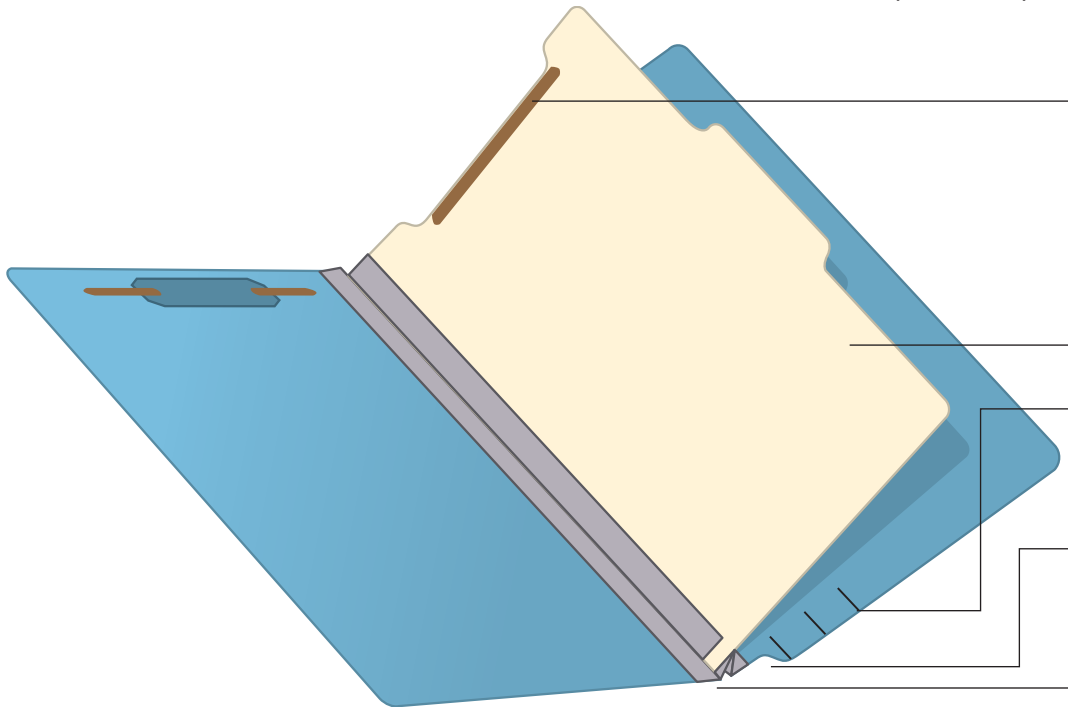

Standard Fasteners

Each section contains two fasteners to securely fasten your documents and keep them in date order. 2" bonded fastener in position 1 & 3 of folder, and one twin-prong fastener on each divider.

11 pt. Manila Dividers

Printed Score Marks

Located to assist in the correct label placement, insuring accurate and consistent color coding.

The "Notch"

TAB designed this undercut so folders fit neatly on shelves with a front lip.

Tyvek® Tape

Virtually indestructible Tyvek connects front panel to back panel forever!

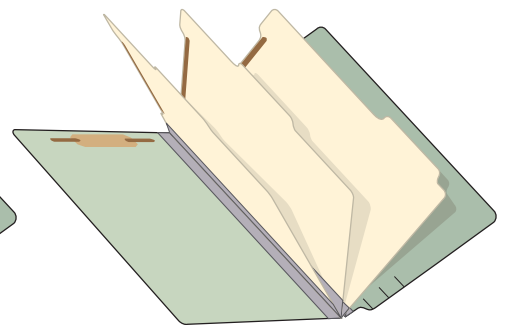
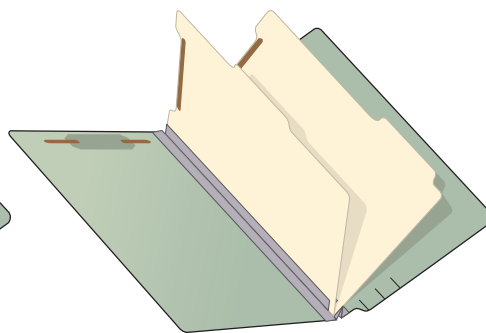
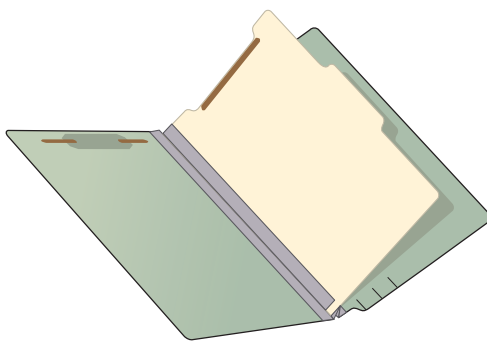

Dividers

One divider file permits two inches of expansion and separation into four sections. Two divider file permits two inches of expansion and separation into six sections. Three divider file permits three inches of expansion and separation into eight sections.

Additional Dividers

Need more than three dividers? Additional dividers can be inserted. Call for a quote.

TAB Folders

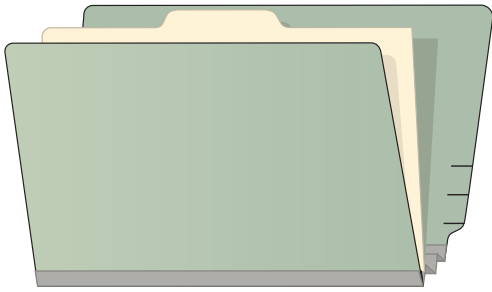

25 pt. Type II – Standard Green/Gray Pressboard

All folders with 1 & 2 dividers have 2" expansion.
All folders with 3 dividers have 3" expansion.
Fasteners included on folder and dividers.

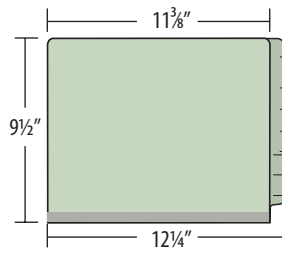

Letter

Model	Description	Carton Wt.	Packed Box/Carton
1244-00B	Standard w/1 divider	34 lbs.	25/100
1245-00B	Standard w/2 dividers	40 lbs.	25/100
NEW! 1243-00B	Standard w/3 divider	47 lbs.	25/100

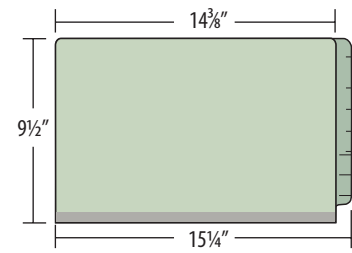

Legal

Model	Description	Carton Wt.	Packed Box/Carton
1246-00B	Standard w/1 divider	42 lbs.	25/100
1247-00B	Standard w/2 dividers	50 lbs.	25/100
NEW! 1248-00B	Standard w/3 dividers	56 lbs.	25/100

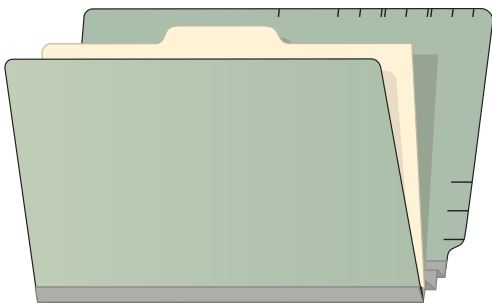

25 pt. Type II – 2TAB Green/Gray Pressboard

All folders with 1 & 2 dividers have 2" expansion.
Fasteners included on folder and dividers.

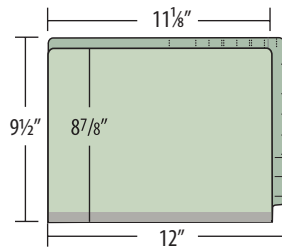

Letter

Model	Description	Carton Wt.	Packed Box/Carton
1352-00B	2TAB w/1 divider	32 lbs.	25/100
1353-00B	2TAB w/2 dividers	38 lbs.	25/100

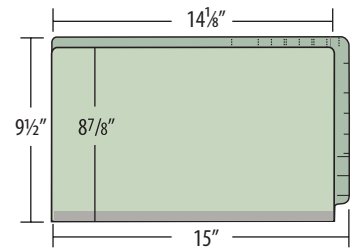

Legal

Model	Description	Carton Wt.	Packed Box/Carton
1354-00B	2TAB w/1 divider	39 lbs.	25/100
1355-00B	2TAB w/2 dividers	48 lbs.	25/100

20 pt. Type I Color Pressboard

All folders with 1 & 2 dividers have 2" expansion.
All folders with 3 dividers have 3" expansion.
Fasteners included on folder and dividers.



Letter

Model	Description	Carton Wt.	Packed Box/Carton
1244-**B	Standard w/1 divider	34 lbs.	25/100
1245-**B	Standard w/2 dividers	40 lbs.	25/100
1352-**B	2TAB w/1 divider	32 lbs.	25/100
1353-**B	2TAB w/2 dividers	38 lbs.	25/100
NEW! 1243-**B	2TAB w/3 dividers	47 lbs.	25/100

Legal

Model	Description	Carton Wt.	Packed Box/Carton
1246-**B	Standard w/1 divider	42 lbs.	25/100
1247-**B	Standard w/2 dividers	50 lbs.	25/100
1354-**B	2TAB w/1 divider	39 lbs.	25/100
1355-**B	2TAB w/2 dividers	48 lbs.	25/100
NEW! 1248-**B	2TAB w/3 dividers	56 lbs.	25/100

**Choose appropriate color suffix:

Colors -02 Blue, -05 Canary, -08 Executive Red and -20 Palm Green readily available in letter size. All other colors and any legal size color pressboard folders may require up to a 35-day lead time.

A Low-Cost Classification Alternative

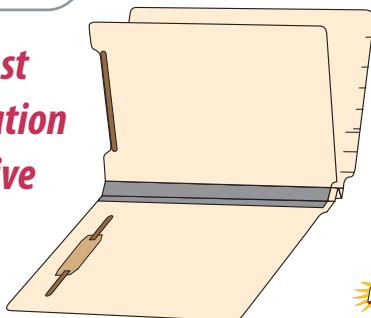

Classification Folder, 1 and 2 Dividers

Ideal for filing large amounts of standard document types and less expensive than the pressboard options! Allows documents to be subdivided within the folder into as many as six categories. These sturdy 18 pt. manila folders expand up to 1 1/2" and have 2" bonded fasteners in positions 1 and 3 of the folder. Each divider has twin prong fastener included.

Model	Description	Carton Wt.	Packed Box/Carton	Model	Description	Carton Wt.	Packed Box/Carton
1258-00B	Letter 9 1/2" x 11 3/4" - 12 1/4" - 1 divider	21 lbs.	25/100	1259-00B	Legal 9 1/2" x 14 3/4" - 15 1/4" - 1 divider	26 lbs.	25/100
NEW! 1268-00B	Letter 9 1/2" x 11 3/4" - 12 1/4" - 2 dividers	25 lbs.	25/100	NEW! 1269-00B	Legal 9 1/2" x 14 3/4" - 15 1/4" - 2 dividers	30 lbs.	25/100



TAB Pockets

Expansion Pockets



Maximum Filing Capacity

Expansion pockets that store 1 3/4", 3 1/2" or 5 1/4" of letter or legal information! Each folder is hand built to protect your most important legal documents.

22 pt. Material

Built to last a lifetime holding ten pounds of information. In file and out.

Colors

More colors than we ever thought imaginable! Full color pockets, color backs or just plain manila.

The "Notch"

TAB designed this undercut to store neatly on shelves with a front lip.

Tyvek® Tape Expansion

Virtually indestructible Tyvek gusset color to match pocket with reinforced tape for extra strength.

Companions to Expansion Pockets

One Piece Small Document Full Side-Tab

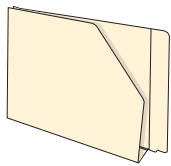

Model	Description	Carton Wt.	Packed Box/Carton
1194-00	14 pt. manila flat (7"h x 10 1/4"w x 11"w overall)	37 lbs.	100/500
1195-00	14 pt. manila 2" exp (7"h x 10 1/4"w x 11"w overall)	25 lbs.	50/250

Smaller Size Pockets – Manila

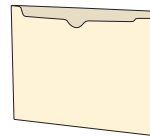

Use inside other folders to create a pocket.

Model	Description	Carton Wt.	Packed Box/Carton
4346-00	11 pt. manila letter, flat (9 1/2"h x 11 3/4"w)	43 lbs.	100/500
4347-00	11 pt. manila legal, flat (9 1/2"h x 14 3/4"w)	27 lbs.	50/250

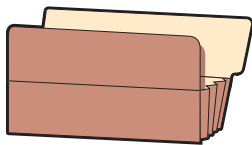

Half Cut End Tab (upper position) Expansion Pocket

Manila back – brown Tyvek® gusset

Model	Description	Carton Wt.	Packed Box/Carton
4397-00	5 1/4" Expansion Pocket – Legal (9 1/2"h x 14 3/4"w x 15 1/4"w overall)	19 lbs.	10/50

Manila Documentation Folders

Cut shorter to fit inside expansion pockets and have a Top-Tab for identification of records contained in the pocket. Embossed score marks are for easy color-coding.

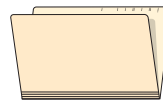

Model	Description	Carton Wt.	Packed Box/Carton
1147-00	9.5 pt. manila letter, single tab (8 7/8"h x 11 1/4"w x 9 1/2"h overall)	34 lbs.	100/500
1156-00	9.5 pt. manila legal, single tab (8 7/8"h x 14 1/4"w x 9 1/2"h overall)	43 lbs.	100/500

22 pt. Red Rope Extra Wide Expansion Pockets

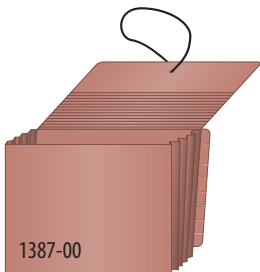

Model	Description	Carton Wt.	Packed /Carton
1385-00	3 1/2" Expansion Pocket without Flap (9 1/2"h x 15 3/8"w x 9 1/2"h x 16 1/8"w overall)	32 lbs.	50
1387-00	5 1/4" Expansion Pocket with Flap (10"h x 15 3/8"w x 10"h x 16 1/8"w overall)	16 lbs.	20

Transporting Your Files?

Do it in style with our fully closable red rope pockets!

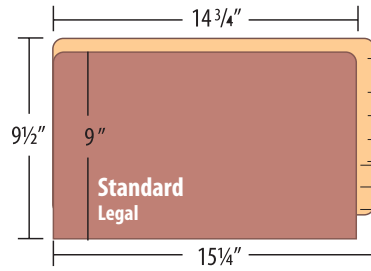
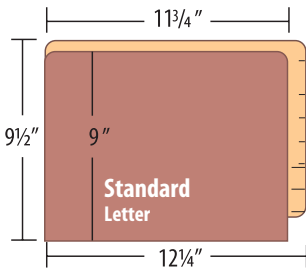

**Choose appropriate color suffix:



22 pt. Red Rope Expansion Pockets with Color Backs

Red rope front and gusset, color back, gusset height 6 1/2"

Letter

Model	Description	Carton Wt.	Packed Box/Carton
1187-**-	1 3/4" Standard Color Back Expansion Pockets	25 lbs.	20/100
1189-**-	3 1/2" Standard Color Back Expansion Pockets	15 lbs.	10/50
4387-**-	5 1/4" Standard Color Back Expansion Pocket	15 lbs.	10/50

Legal

Model	Description	Carton Wt.	Packed Box/Carton
1191-**-	1 3/4" Standard Color Back Expansion Pocket	29 lbs.	20/100
1193-**-	3 1/2" Standard Color Back Expansion Pockets	19 lbs.	10/50
4397-**-	5 1/4" Standard Color Back Expansion Pocket	19 lbs.	10/50

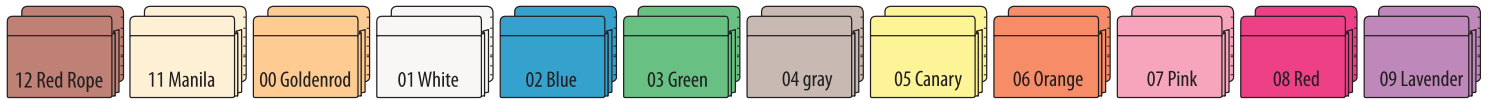

22 pt. Standard Solid Color Expansion Pockets

Letter

Model	Description	Carton Wt.	Packed Box/Carton
1378-**-	1 3/4" Standard Solid Color Expansion Pockets	25 lbs.	20/100
1379-**-	3 1/2" Standard Solid Color Expansion Pockets	15 lbs.	10/50

Legal

Model	Description	Carton Wt.	Packed Box/Carton
1380-**-	1 3/4" Standard Solid Color Expansion Pockets	29 lbs.	20/100
1381-**-	3 1/2" Standard Solid Color Expansion Pockets	18 lbs.	10/50

**Choose appropriate color suffix:

Low Gusset Expansion Pockets

Red rope front and gusset, goldenrod back, left gusset height 9", right gusset height 1 1/2"

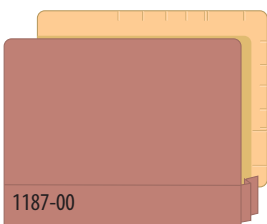

22 pt. 2TAB Red Rope Front and Bright Goldenrod Back

Letter

Model	Description	Carton Wt.	Packed Box/Carton
1187-00	1 3/4" Expansion (9 1/2" h, 11 1/2" w x 12 w overall)	25 lbs.	20/100
1189-00	3 1/2" Expansion (9 1/2" h, 11 1/2" w x 12 w overall)	15 lbs.	10/50

Legal

Model	Description	Carton Wt.	Packed Box/Carton
1191-00	1 3/4" Expansion (9 1/2" h, 14 1/2" w x 15" w overall)	29 lbs.	20/100
1193-00	3 1/2" Expansion (9 1/2" h, 14 1/2" w x 15" w overall)	18 lbs.	10/50



22 pt. 2TAB Solid Color Pockets

Letter

Model	Description	Carton Wt.	Packed Box/Carton
1356-**-	1 3/4" 2TAB Solid Color Expansion Pockets (9 1/2" h, 11 1/2" w x 12 w overall)	23 lbs.	25/100
1357-**-	3 1/2" 2TAB Solid Color Expansion Pockets (9 1/2" h, 11 1/2" w x 12 w overall)	14 lbs.	10/50

**Choose appropriate color suffix from colors above.



Custom Indexes

Increase the speed of access to critical documents!

Keep your records neatly organized and quickly accessible with Custom Indexes. Custom Indexes allow you to apply classification and indexing to organize and reference the contents of your folder.

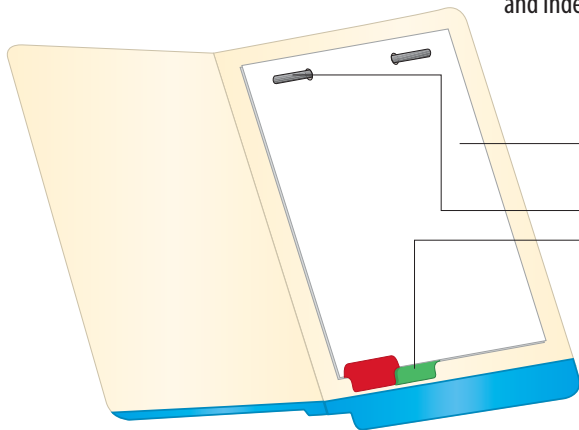

90# Material

Manila or White

Holes

Two round Mylar-reinforced

TABs

Black printing on two sides, mylar coated.

Customize color choices on next page.

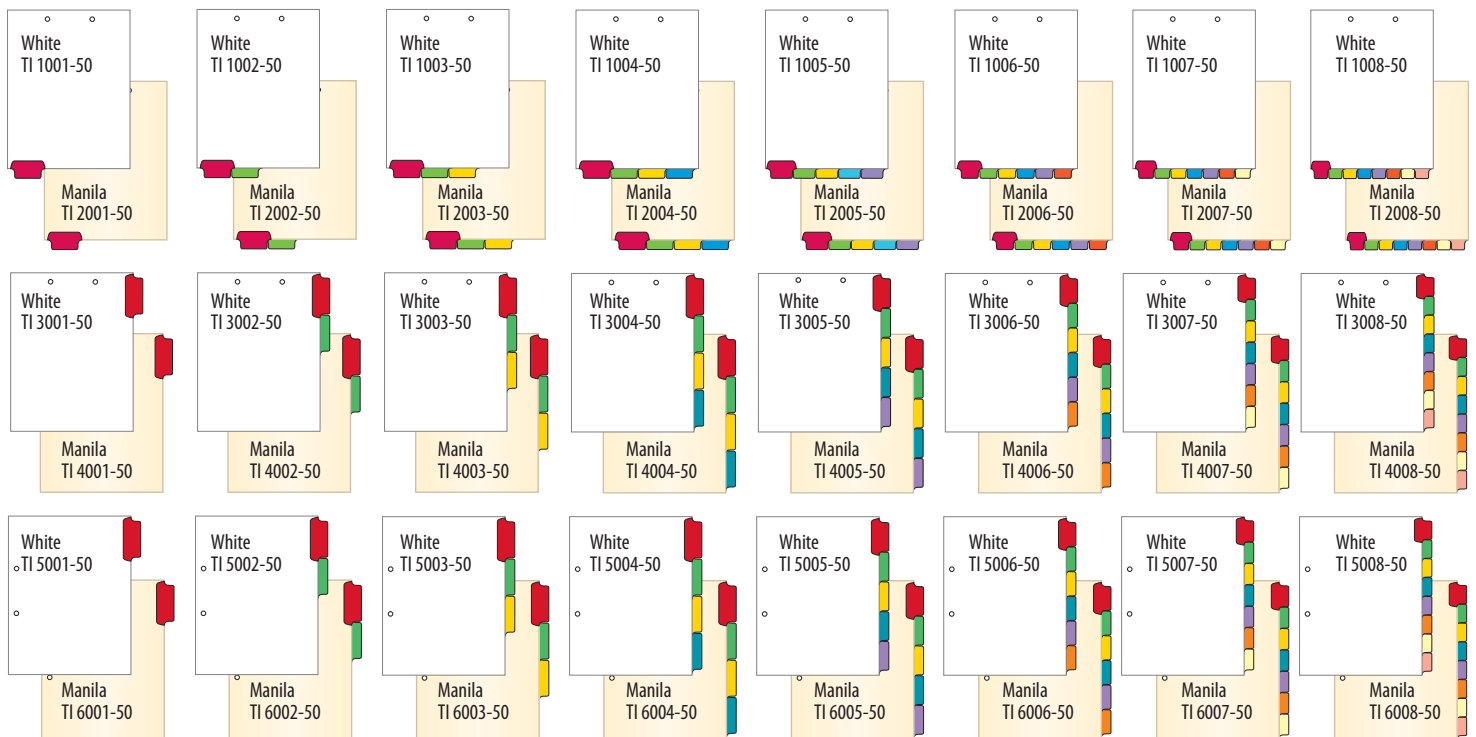
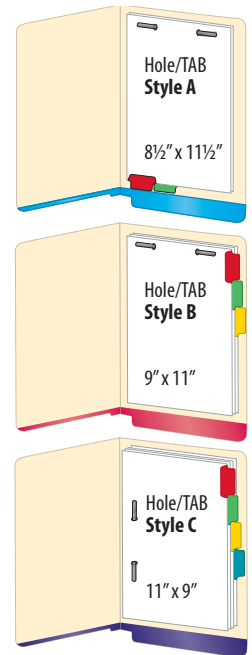

1 TAB - 1/4 cut

2 TAB - 1/4 cut

3 TAB - 1/4 cut

4 TAB - 1/4 cut

5 TAB - 1/5 cut

6 TAB - 1/6 cut

7 TAB - 1/7 cut

8 TAB - 1/8 cut



Follow these simple instructions to create your customized index solutions

SIMPLE SOLUTIONS

If you like our standard indexes, but want different tab colors, then fill in the model # here:

and indicate your color choices at the top of the third column on this page (under Add the TAB)

Customer # _____

Customer Name _____

Date _____

Phone _____

For Office Use Only

M# _____

Ack# _____

Quote # _____

Price # _____

Lead Time _____

SELECT YOUR PAPER STYLE

(tab/hole position)

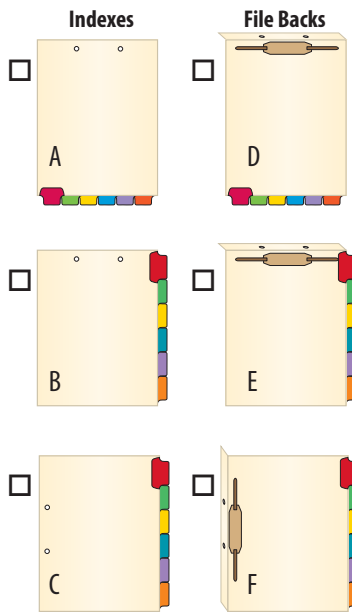

Select Size

- Letter Legal

Weight

- Standard White 90#
 Heavy white 110#
 Standard manila 90#
 Heavy manila 110#
 90# Buff

TAB Size

- 1/4" extension
 3/8" extension
 1/2" extension – standard
 Other length: _____

Holes

- Round – standard
 2 Holes
 3 Holes
 Reinforced
 Other: _____

ADD THE TAB

No.	Qty.	Color
<input type="checkbox"/> 1	_____	_____
<input type="checkbox"/> 2	_____	_____
<input type="checkbox"/> 3	_____	_____
<input type="checkbox"/> 4	_____	_____
<input type="checkbox"/> 5	_____	_____
<input type="checkbox"/> 6	_____	_____
<input type="checkbox"/> 7	_____	_____
<input type="checkbox"/> 8	_____	_____
<input type="checkbox"/> More (attach instructions)		

Color tabs are made by laminating color gloss laminate to the tab.

Number of tabs per bank: _____

Number of banks: _____

- Gloss Mylar (see colors)
 Matte Mylar (clear only, writable)
 No Mylar (tab is color of paper)

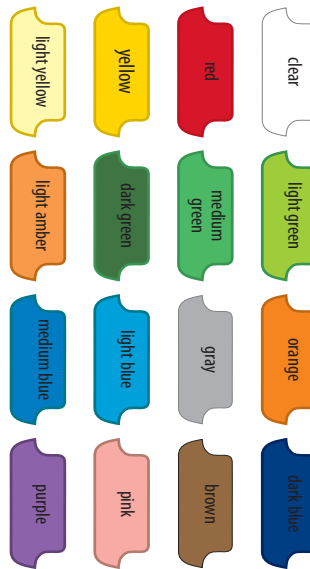

PRINTING ON TABS

- One side Two sides

Ink Color

- Black
 PANTONE® #: _____

Print Style

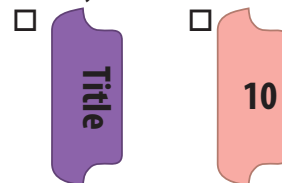

SELECT YOUR OPTIONS

TAB Titles

- 1 _____
 2 _____
 3 _____
 4 _____
 5 _____
 6 _____
 7 _____
 8 _____

- More (attach instructions)

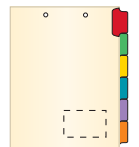

Printing

- Logo printing (3" x 2")

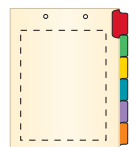

- Body printing

Ink Color

- Black
 PANTONE® no: _____

Collating/Packaging

- Collated Into Sets
 Special Collating
 Special Packaging

Re-Confirmation Sketch

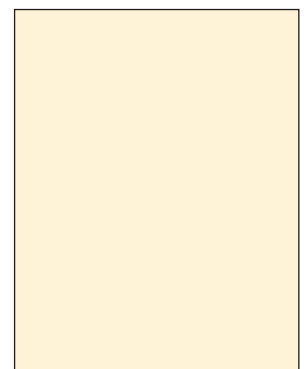

Indicate tab location, holes, etc.



Custom Fasteners

Fasteners

Need to permanently attach documents to your folder? Use these fasteners to convert your plain manila folder to a fastener folder quickly and permanently! From a simple self adhesive fastener, to a twin prong, or use a Docuclip fastener. Docuclips permit you to save time allowing you to interfile without removing pages.



#1108-00



#1108-01



#1149-00



Model B

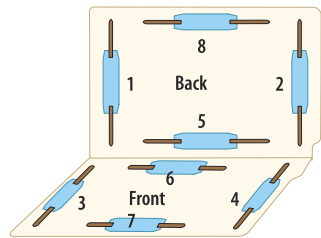

Fasteners

FACTORY INSTALLED

Model	Description
B	2" Bonded Fastener

SELF INSTALLED

Model	Description	Carton Wt.	Packed Box/Carton
1108-00	2" Self Adhesive	24 lbs.	500/2,500
1108-01	1" Twin Prong	24 lbs.	100/4,000
1108-02	2" Twin Prong	24 lbs.	100/4,000
1149-00	2" Self Adhesive Foamclip	30 lbs.	100/4,000

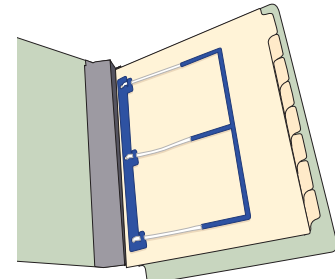
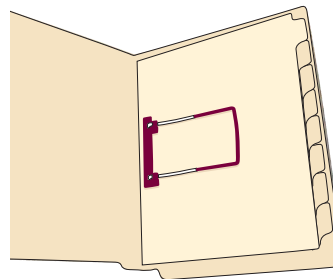
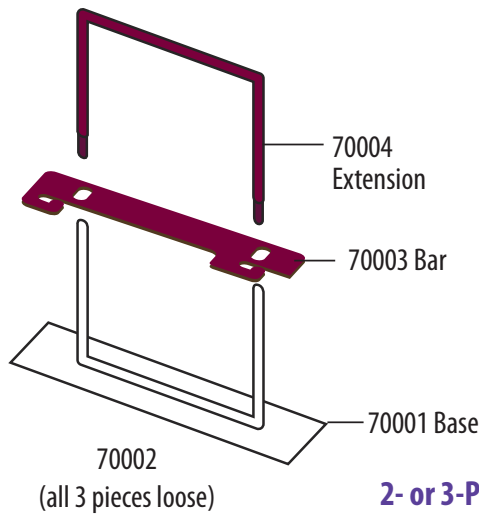

2- or 3-Prong DocuClip

This unique plastic fastener is an alternative to three-ring binders for active or inactive records. An ideal alternative when converting documents from bulky binders into a pressboard expansion folder!

This fastener has a self-adhesive back allowing for easy insertion into any file folder. It's flexible, three piece design features legs that are easily removed so documents can be inserted, removed or copied without disturbing preceding pages.

DocuClip Fasteners

FACTORY INSTALLED

Model	Description
E=70001	2-Prong Docuclip
	3-Prong Docuclip

SELF INSTALLED

Model	Description	Package Wt.	Packed /Package
70002	2-Prong Docuclip – complete - 3 pieces	2 lbs.	100
70001	2-Prong Docu Base	1 lbs.	100
70003	2-Prong Docu Bar	1 lbs.	100
70004	2-Prong Docu Extension	1 lbs.	100
70010	3-Prong DocuClip – complete - 3 pieces	5 lbs.	100

Looking for another solution for 3-ring applications?

See page 35.

Custom Pockets and Printing

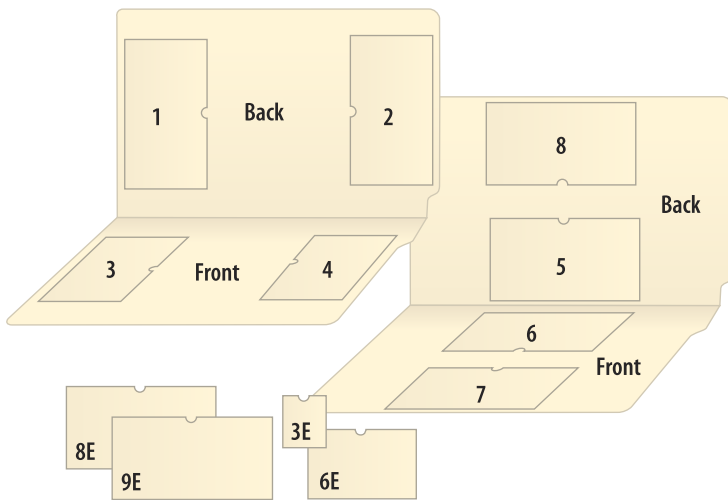

Manila Pockets

Want to keep small items from falling out of your file? Add a manila pocket in one or several locations. From credit cards to letter size documents these factory installed pockets can improve your information process.

FACTORY INSTALLED

Model	Description
F	3E Manila 2 1/2" w x 3" h
G	6E Manila 6 1/2" w x 4" h
H	8E Manila 8 3/8" w x 4 1/2" h
J	9E Manila 9 1/2" w x 4 1/2" h
K	Vinyl 2 1/2" w x 3 3/8" h (1159-00)
L	Vinyl 6" w x 4" h (1160-00)
M	Vinyl 8 1/2" w x 5" h (1161-00)

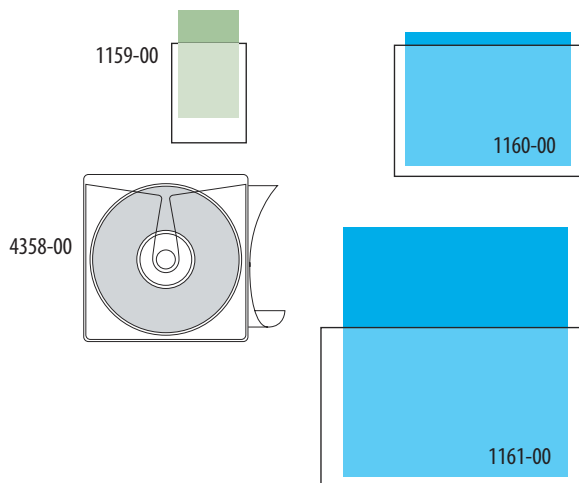

Clear Vinyl Pockets

Small documents can be organized and secured within a file using pockets. Made from vinyl each has a self adhesive back to firmly attach the pocket to the folder.

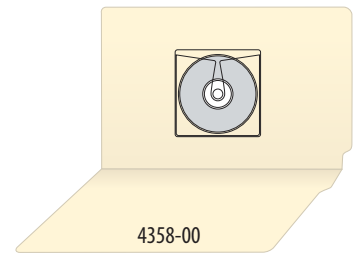

SELF INSTALLED

Model	Description	Carton Wt.	Packed /Carton
1159-00	Vinyl 2 1/4" w x 3 1/8" h	5 lbs.	100/500
1160-00	Vinyl 6" w x 4" h	13 lbs.	100/500
1161-00	Vinyl 8 3/4" w x 5" h	21 lbs.	100/500
4358-00	Vinyl 5 1/4" x 5 1/4" — Stock runout	40 lbs.	100/600

All dimensions are inside dimensions.

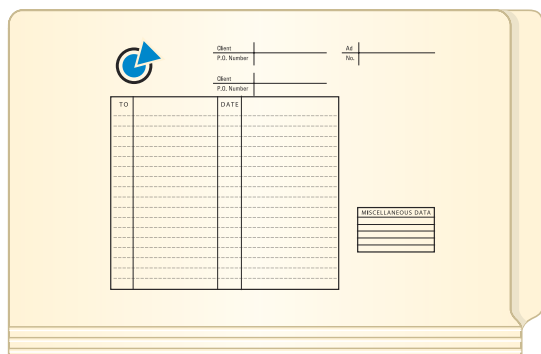

Printing

Outside Front, Inside Front, Inside Back, Outside Back. 500 or 100,000. One Color. Two colors. Your artwork. Our artwork. Tab can print whatever you want wherever you want it.

FACTORY INSTALLED

Model	Description
P	Printing One Color One Panel
Q	Printing Numbering on Folder
R	Printing Two Colors One Panel

500 piece minimum for printing.



Custom Dividers

Custom Dividers

Keep information in organized groups within your folder with installed dividers. Optional twin prong fastener allows for attaching documents on either side of the divider.

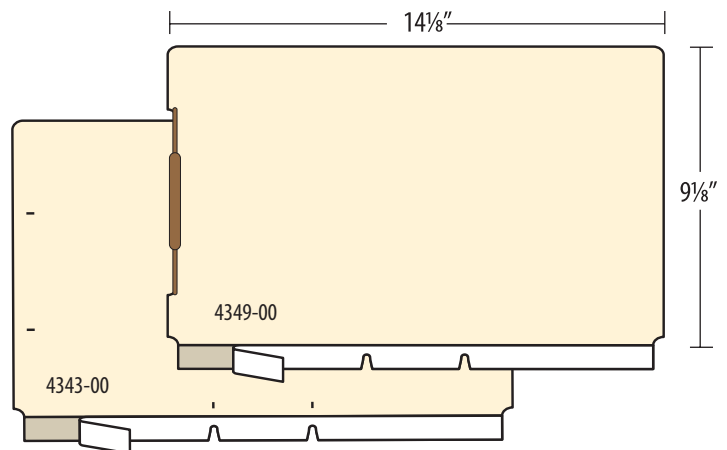
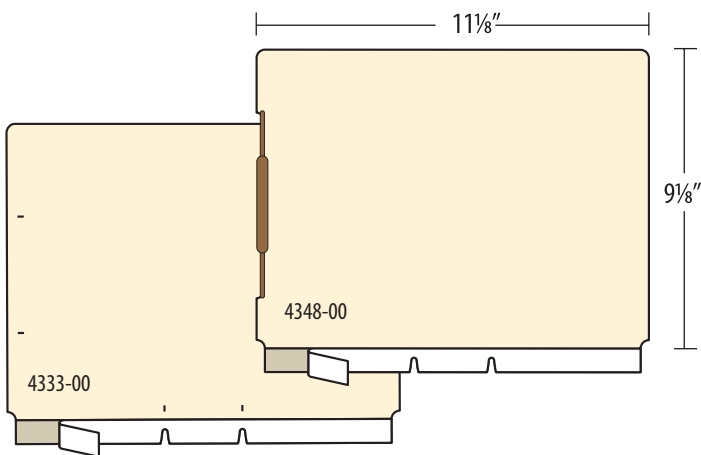
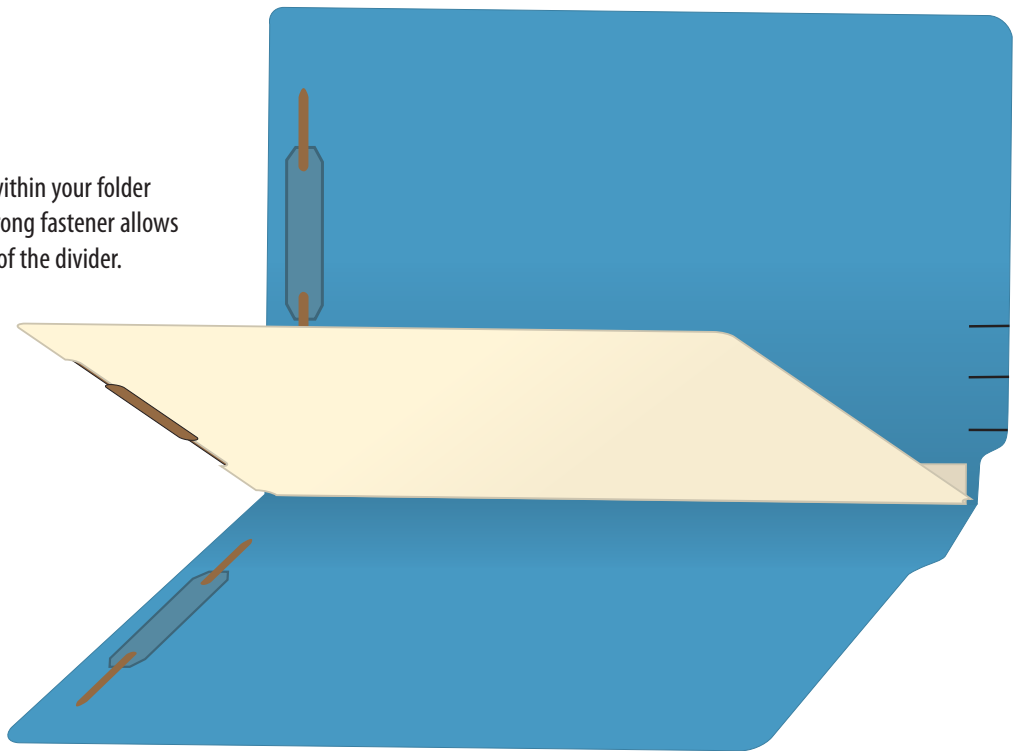

Pressure-Sensitive Dividers

Made of 11 pt. Manila, convert files to multiple classifications.

Letter

FACTORY INSTALLED

Model	Description
N=4333-00	9 1/8" h x 11 1/8" w
O=4348-00	9 1/8" h x 11 1/8" w with 1" twin prong fastener

Letter

SELF INSTALLED

Model	Description	Carton Wt.	Packed /Carton
4333-00	9 1/8" h x 11 1/8" w	23 lbs.	100/500
4348-00	9 1/8" h x 11 1/8" w with 1" twin prong fastener	26 lbs.	100/500

Legal

FACTORY INSTALLED

Call for quote.

Legal

SELF INSTALLED

Model	Description	Carton Wt.	Packed /Carton
4343-00	9 1/8" h x 14 1/8" w	26 lbs.	100/500
4349-00	9 1/8" h x 14 1/8" w with 1" twin prong fastener	29 lbs.	100/500

Top/Side Conversion



Easy as 1

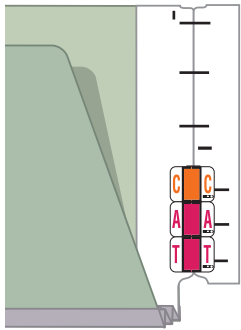

...2

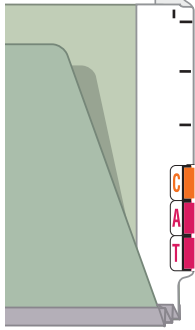

...3

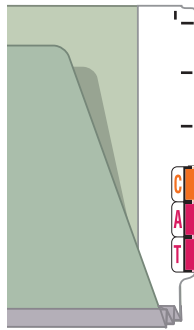

Convert-a-Tab

Change your top tab folder to an end tab folder using this self adhesive heavy white label stock. Remove the backing sheet, align the crease with the top and bottom of your folder edge and wrap the convert a tab over the edge.

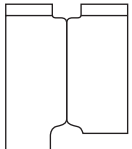

4302-01

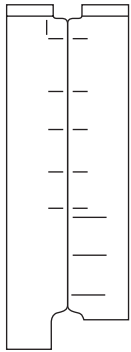

4302-50

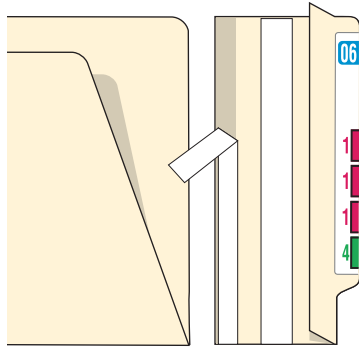

4302-DPT

SELF INSTALLED TO LETTER OR LEGAL SIZED FOLDERS

Model	Description	Carton Wt.	Packed Box/Carton
4302-50	9" h white tag	61 lbs.	500/5,000
4302-01	4" h white tag	32 lbs.	500/5,000
4302-DPT	8¼" h Manila Double Ply	15 lbs.	100/500

Tab will no longer offer/quote the attaching of Compucolor or Filepak labels to the 4302-50 or 4302-01 convert-a-tabs (white). Both these models will continue to be stock items with immediate availability.

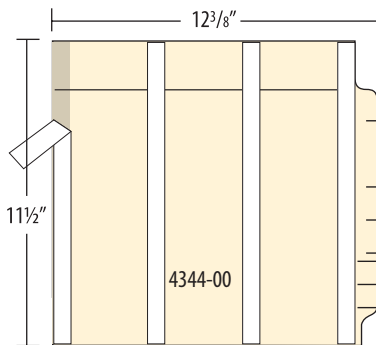

4344-00

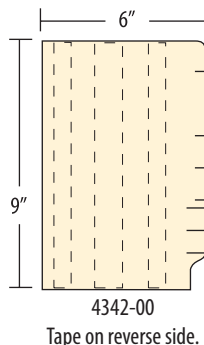

4342-00

Tape on reverse side.

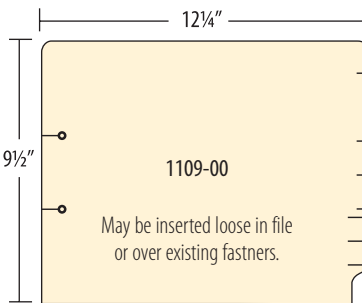

1109-00

May be inserted loose in file or over existing fasteners.

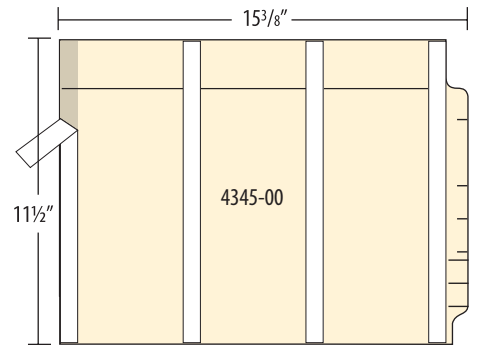

4345-00

File Backs

Convert your top tab folders to a side tab folder with this easily insertable manila fileback. Optional fastener or adhesive strips insure that the File Back stays firmly attached to your existing folder.

Cov'r'tabs

Do not throw away that color coded folder if it still can be used. Cov'r'tabs make it easy to allow re-coding of previously color coded file folders with its wrap-around design and printed guide marks for positioning of new color-code labels.

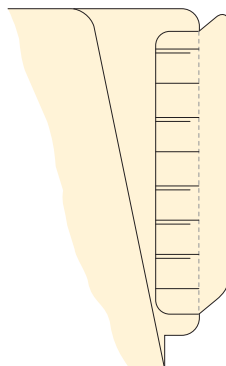

Letter

SELF INSTALLED

Model	Description	Carton Wt.	Packed Box/Carton
4344-00	14 pt. self adhesive 11½" h x 12 3/8" w	6 lbs.	100
4342-00	14 pt. self adhesive 9" h x 6" w	28 lbs.	200/1,000
1109-00	11 pt. keyhole 9 1/2" h x 12 1/4" w	23 lbs.	100/500

Legal

SELF INSTALLED

Model	Description	Carton Wt.	Packed Box/Carton
4345-00	14pt self adhesive 11½" h x 15 3/8" w	9 lbs.	100

SELF INSTALLED

Model	Description	Carton Wt.	Packed Box/Carton
4404-00	60 lb. self-adhesive, 2½" x 8"	.5 lbs.	50



TAB Labels

Increase Productivity - Improve Customer Service - Achieve Business Objectives

Using a color-coded filing method can dramatically reduce file retrieval time. Color-coding assigns colors to represent letters and/or numbers which create color block patterns that are visually easy to scan. TAB offers several color-coded solutions on the following pages.

Alphabetic Labels

Alphabetic Color-Coding is the arrangement of files by name, company or subject. Alphabetic order is the most common and popular method for filing systems under 5,000 records. Alpha filing allows direct access to files because a cross-reference is not needed. Large volume alpha systems have repetitions (common last names) that hinder filing efficiency. Therefore, alpha systems that are over 10,000 records should have further color code divisions, such as adding a color code for first letter, first name and/or the third letter of the last name. This provides further distinction in larger file groups.

Options for Alphabetic Color-Coding:

Hand Wrap Labels

Select and apply individual labels that are printed with inks and coated with adhesives that last a lifetime.

CompuColor Strip Labels are data driven and have unlimited options, including any color palette, lines of cross-reference, highlighting, font options, even company logos. These labels are totally customizable.



Sample alpha label configurations

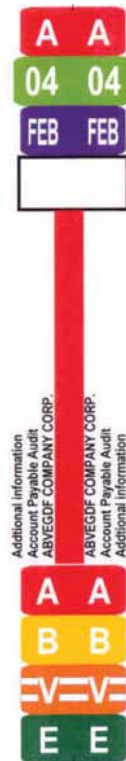

Accounting



Education

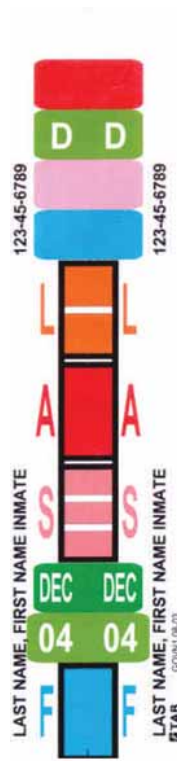

Government



Medical



Legal

Self-Adhesive Labels



Alphacode

Instantly recognize files on a shelf or a desk with these self-adhesive labels. Available in boxes of 500 or sheets of 50

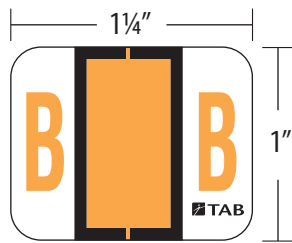

1" Color Coded Labels – Boxes

Alphacode – Replace * with desired letter A-Z

Model	Description	Box Wt.	Labels/Box Box/Set
1283-*	1" High Alphabetic Color Label	2.6 oz.	500
1283-50	1" High Alphabetic Color Label Complete Set – 1 box each	6.5 lbs.	26/set

(Mc available as single box only not available in 1283-50 set)

1283 & 1286 colors

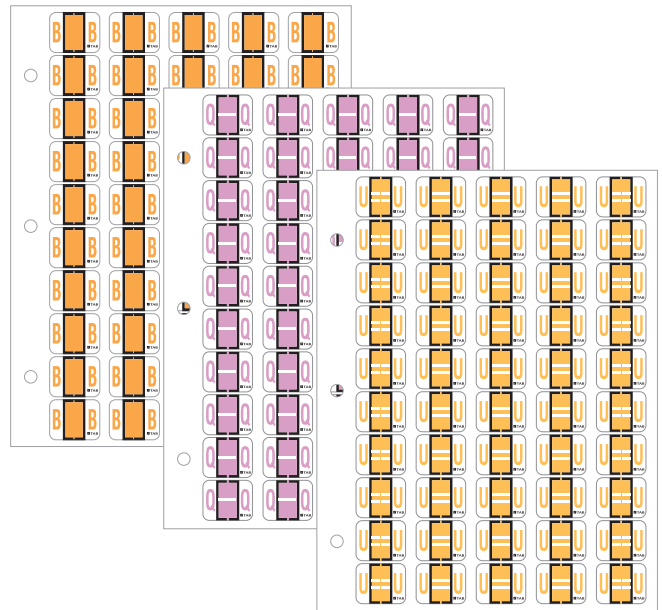

1" Color Coded Label – Sheets

Alphacode – Replace ** with desired letter A-Z

Model	Description	Box Wt.	Labels/Sheet Labels/Box
1286-*	1" High Alphabetic Sheet Labels – 50 labels/sheet	0.3 oz.	50
1286-00	1" High Starter Set A to Z (3,100 labels) 100 ea. consonant; 200 ea. vowel	2 lbs.	62
1286-50	Binder and index set for storing starter set (1286-00)	1.5 lbs.	

TABSTIK label colors

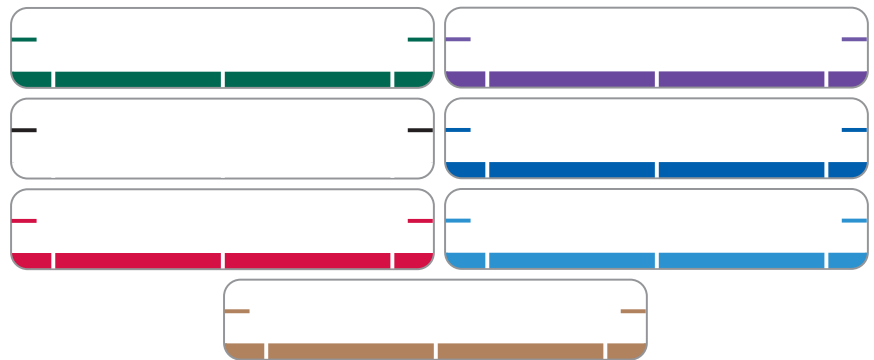

Actual label size is 3 3/8" x 9/8"

1/2" Color Coded Classification Labels

Alphacode – Replace * with desired letter A-Z

Model	Description	Box Wt.	Labels/Box Box/Set
1278-*	1/2" High Alphabetic Color Label	1.3 oz.	500
1278-50	1/2" High Alphabetic Color Label Complete Set – 1 box each	4 lbs.	26/set



TABSTIK Name Labels

Model	Description	Box Wt.	Labels/Sheet Labels/Box
1389-00	Dark Green	5.6 oz.	24/504
1390-00	White	5.6 oz.	24/504
1394-00	Red	5.6 oz.	24/504
1396-00	Purple	5.6 oz.	24/504
1397-00	Dark Blue	5.6 oz.	24/504
1398-00	Light Blue	5.6 oz.	24/504
1401-00	Tan	5.6 oz.	24/504
1303-90	White for Laser Printers	1.5 lbs.	30/750
1290-00	White Pinfeed Labels	2 lbs.	36/2520



Self-Adhesive Labels

Numeric Labels

Numeric Color-Coding is a method of filing where consecutively numbered folders are placed in the filing system in sequential order.

Straight Numeric systems are the most practical systems in larger file rooms – filed lowest to highest number. Typically, color coding illustrates all of the digits of the number. Policies, invoices, accounts and claims are examples of records referenced by number. Unlike alpha systems, there is no duplication. Each number is unique and file confidentiality is enhanced because access to a record is not possible without a cross reference (database).

Terminal Digit filing is a method of arranging folders so that all numbers with like ending digits are grouped together. Terminal digit does not change the number of the files – it is simply an organization technique that uses numbers to divide files into unique and easily located groups. This provides an orderly way to maintain files with random number assignment or skips in numbers.

Options for Numeric Color-Coding:

Hand Wrap Labels

Select and apply individual labels that are printed with inks and coated with adhesives that last a lifetime.

FilePak “Classic” Strip Labels are available for Straight Numeric systems only. They have the following options: standard format, tab colors and classification. No bar coding available.

FilePak “Full Feature” Strip Labels are available for Straight Numeric systems. However, these have unlimited color palette options, which allow matching to any competitor. Bar code, 3 of 9, with or without check digit.

CompuColor Strip Labels are data driven and have unlimited options, including any color palette, lines of cross-reference, highlighting, font options, even company logos. These labels are totally customizable.

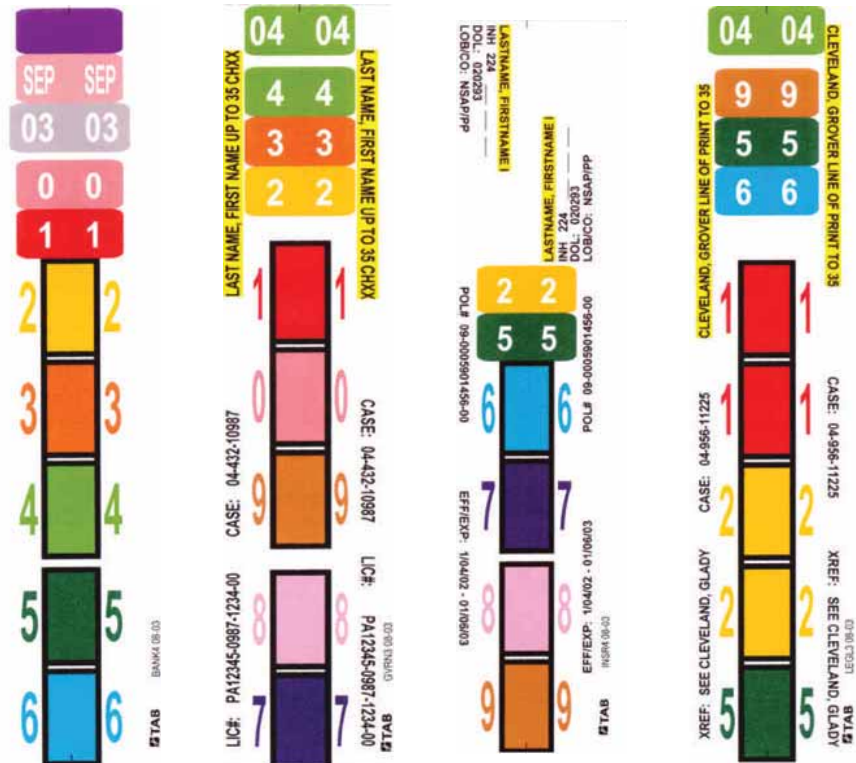
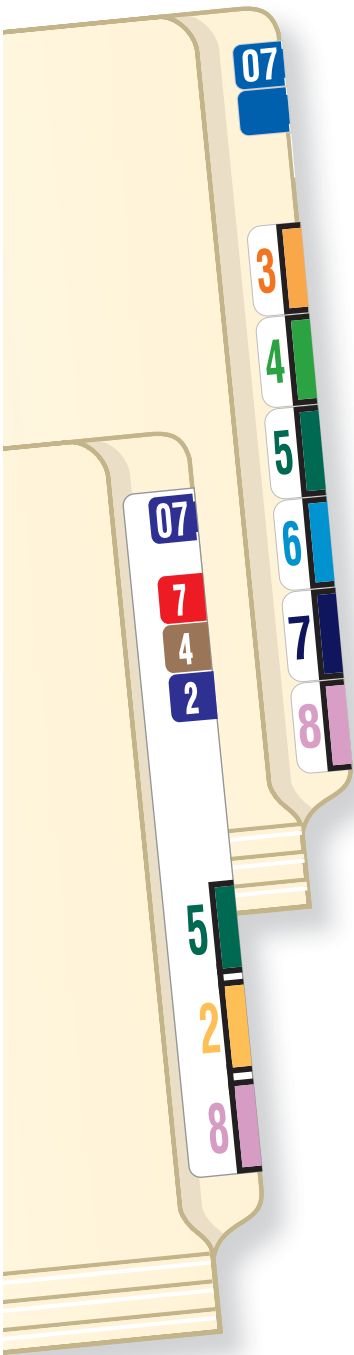

Sample numeric label configurations

TAB Self-Adhesive Labels



Compucolor

Social Security Numbers, Account Numbers, Credit Cards, Zip Codes, Invoice Numbers and Dates can all be identified with these self adhesive numeric color coding labels.

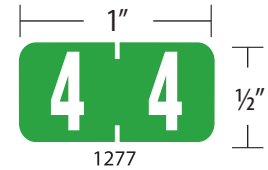
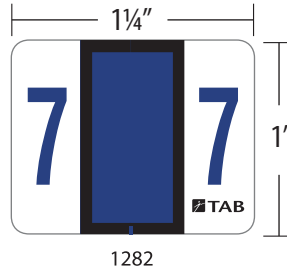

1282 & 1277 colors

Compucolor – Replace ** with desired number 00 - 09

Model	Description	Box Wt.	Labels/Box Box/Set
1282-**	1" High Numeric Color Label	2.6 oz.	500
1282-50	1" High Numeric Color Label Complete Set – 1 box each	3 lbs.	10/set

Compucolor – Replace ** with desired number 00 - 09

Model	Description	Box Wt.	Labels/Box Box/Set
1277-**	1/2" High Numeric Color Label	1.3 oz.	500
1277-50	1/2" High Numeric Color Label Complete Set 0 to 9 Box	2.5 lbs.	10/set

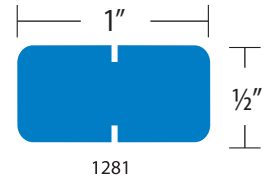
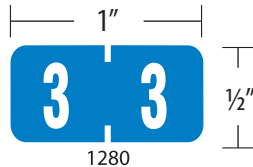

TABSTIK Numeric – Replace ** with desired number 00 - 09

Model	Description	Box Wt.	Packed Labels/Box
1280-**	1/2" High TABSTIK Numeric Classification Labels	2.2 oz.	1,000
1280-50	1/2" High TABSTIK Numeric Classification Labels Complete Set 0-9	3 lbs.	10/set



1280 colors

Solid Color Labels

Model	Description	Carton Wt.	Packed Box/Carton
1281-**	1/2" High Solid Color Classification Labels	2.3 oz.	1,000
1281-50	1/2" High Solid Color Classification Labels (12 colors)	3 lbs.	12/set

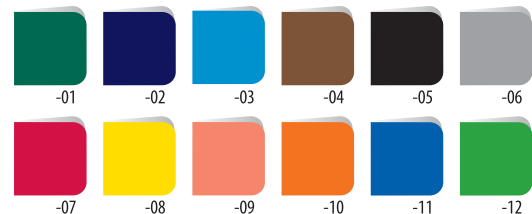

1281 colors



TABQUIK® Labels

High Quality Labels

The TABQUIK® label is a high quality, smear-proof, coated stock, with a long lasting acrylic based adhesive. TABQUIK® labels will go on, stay on and remain legible for the entire life cycle of your files.



7 labels per sheet – 7.75" x 1.66"
Model #6304-00 (inkjet) 1750/Box

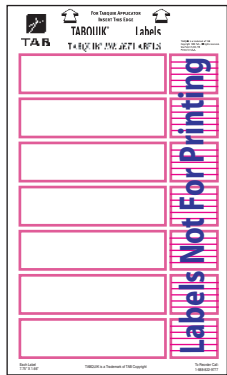

7 labels per sheet – 6.25" x 1.66"
Model #6304-20 (inkjet) 1750/Box

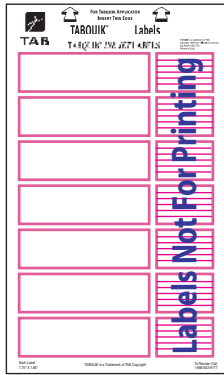

7 labels per sheet – 5.0" x 1.66"
Model #6304-40 (inkjet) 1750/Box

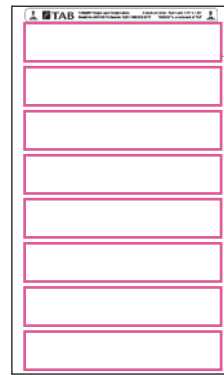

8 labels per sheet – 7.75" x 1.66"
Model #6307-00 (inkjet) 400/Box

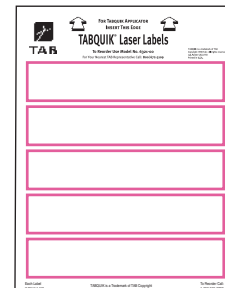

5 labels per sheet – 7.75" x 1.66"
Model #6321-00 (laser) 1500/Box
Model #6324-00 (inkjet) 500/Box

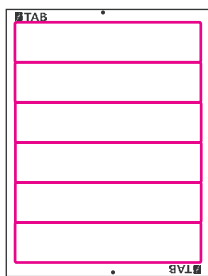

6 labels per sheet – 7.75" x 1.66"
Model #6321-HA (laser) 1800/Box
Model #6321-HA50 (laser) 300/Box
Model #6324-HA (inkjet) 1800/Box
Model #6324-HA50 (inkjet) 300/Box

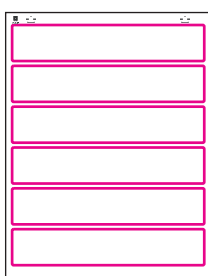

6 labels per sheet – 1.5" x 8"
Model #6376-00* (inkjet) 1500/Box
Model #6379-00* (laser) 1500/Box
Model #6384-00+ (laser) 1500/Box
Model #6408-00+ (inkjet) 1500/Box

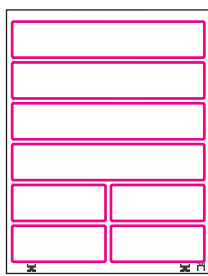

4 sets of 2 labels per sheet
4–1.5" x 8" / 4–1.5" x 3.87"
Model #6377-00* (inkjet)
Model #6380-00* (laser)
1000 Sets/Box



6 labels per sheet
1.5" x 8" notched
Model #6378-00+ (inkjet)
1500 Sets/Box



12 labels per sheet
3.875" x 1.66" notched
Model #6403-00 (laser)
Model #6403-00 (laser)
3600 Sets/Box

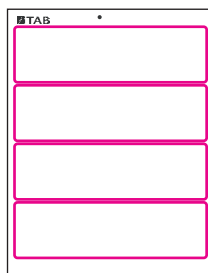

4 labels per sheet 2-5/16" x 8"
Model #6382-00+ (poly laser)
1000/Box

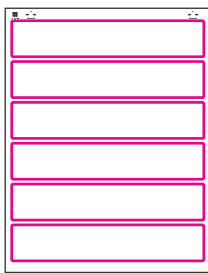

6 labels per sheet 1.875" x 8"
Model #6383-00+ (poly laser)
1500/Box

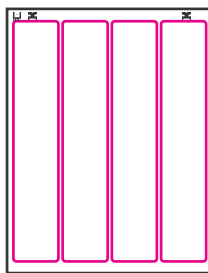

4 X-Ray labels per sheet 1.875" x 10"
Model #6400-00* (inkjet)
1000/Box



7 labels per sheet 1-7/16" x 8"
Model #6412-00+ (laser)
Model #6413-00+ (inkjet)
1008/Box

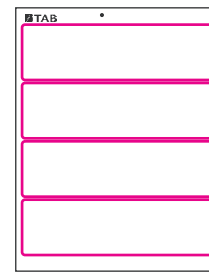

4 labels per sheet 2-5/16" x 8"
Model #6381-00+ (opaque laser)
1000/Box

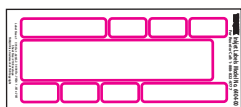

9 labels per sheet 1–7.75" x
1.66"; 2–3.438" x .75"; 6–1.5" x .75"
Model #6404-00 (inkjet)
Model #6409-00 (laser)
100 sheets/Pk #10 envelope size

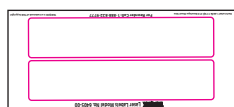

2 labels per sheet 7.75" x 1.66"
Model #6405-00 (laser)
Model #6410-00 (inkjet)
100 sheets/Pk #10 envelope size

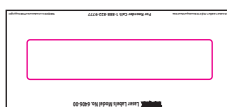

1 label per sheet 7.75" x 1.66"
Model #6406-00 (laser)
Model #6411-00 (inkjet)
100 sheets/Pk #10 envelope size

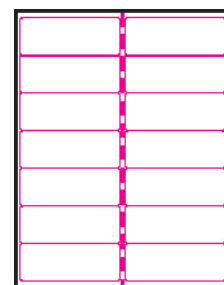

14 labels per sheet 4" x 1.5"
Model #6414-00+ (laser)
1400 labels/100 sheets

- + Smear ColorBar Match
- GBS NetLabels Match
- * ColorFlex Match



Color-Coded Labels on Demand

TABQUIK® 7 is labeling software that provides you with an easy and efficient way to color-code files and other media for timely organization and retrieval. The laborious task of creating and applying color-coded labels to file folders and other media is made easy. With TABQUIK® 7, you get on-site color-coded labels on demand.

The Total Solution

TABQUIK® 7 is a scalable, Windows®-based software solution that allows you to set a color-coded and labeling standard across your entire enterprise. To meet individual and multiuser requirements, TABQUIK® 7 and Enterprise are available in Stand-Alone and Network versions.

Features

- ✓ Convert data into color bars, bar codes and file identification text
- ✓ User-selectable color palette - match any system
- ✓ One custom and eight standard label designs included – unlimited label designs are available for a nominal fee
- ✓ Print top tab and side tab labels using the same data file – one right after the other
- ✓ Produce labels for file folders, videotapes, data tapes, flexible diskettes or other media - possibilities are limitless
- ✓ Project Associations - you define how TABQUIK® works on your workstation
- ✓ Enter data via a grid (worksheet) or from a form
- ✓ Sort data by clicking on a grid column header
- ✓ Preview your labels as you key them in, all on the same screen, or as you select them for printing
- ✓ Automatically print your labels when you send a file from your computer system (database)
- ✓ Create your own drop down list for faster data entry

TABQUIK Software and Support

Model	Description
6701DT-S	TABQUIK v7 STANDALONE Includes first year of maintenance
6301B-PR	TABQUIK – 1 Year Standalone – Renewal Maintenance Renewal includes CD or upgrade to current version
6701DT-N	TABQUIK v7 DESKTOP – Network Includes first year of maintenance
6316-PR	TABQUIK – 1 Year Network – Renewal Maintenance Renewal includes CD or upgrade to current version



Specialty Labels

Label Organizer Box

Label organizer box holds individual boxes for organizing CompuColor, AlphaCode, Classification, Year, Month, Solid and Color-Bar labels.

The 1274-DBL holds a complete set of 26 alpha and a space for one additional box to add a year label or the Mc label.

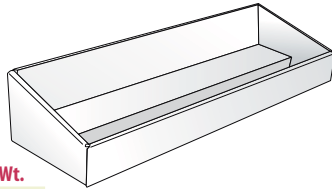

Model	Description	Box Wt.
1274-DBL	Double Organizer Box	1

*(1) Organizer box included at N/C with each label set purchased.

The 1274-SGL organizer holds a complete numeric set of 10 boxes.

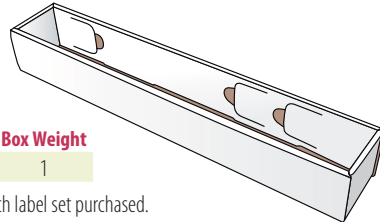

Model	Description	Box Weight
1274-SGL	Single Organizer Box	1

*(1) Organizer box included at N/C with each label set purchased.

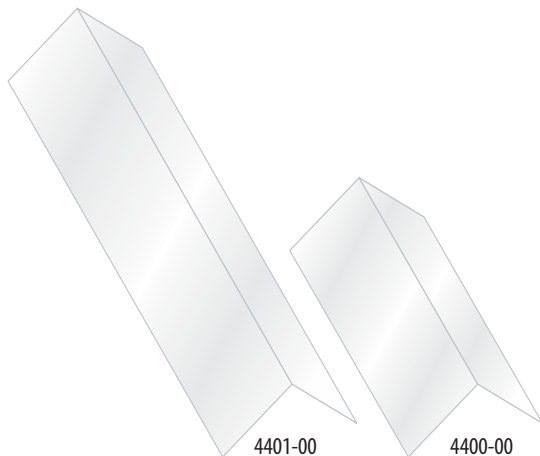

Label Protectors

Extend your shelf life with clear wrap around self adhesive label protectors.

Model	Description	Box Wt.	Qty/Box
4400-00	2" w x 4" h	2 lbs.	500
4401-00	2" w x 8" h	.5 lbs.	100

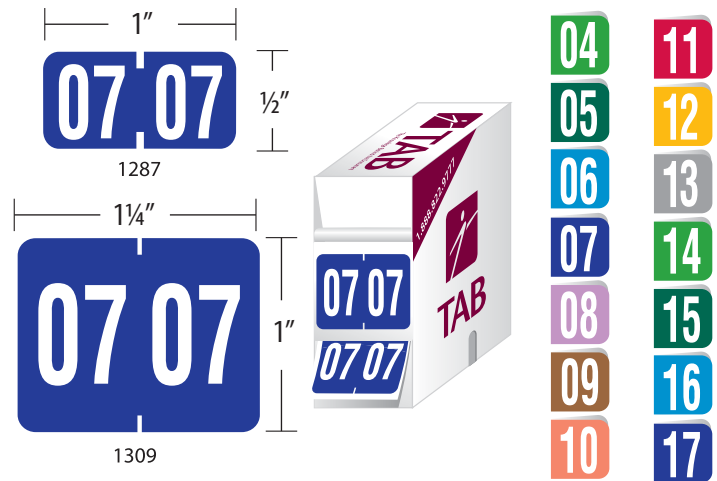

Year Labels

Model	Description	Box Wt.	Packed Labels/Box
1287-**-	½" High 2 Digit Year Label (replace ** with number of year desired)	1.5 oz.	500
1309-**-	1" High 2 Digit Year Label (replace ** with number of year desired)	2.6 oz.	500

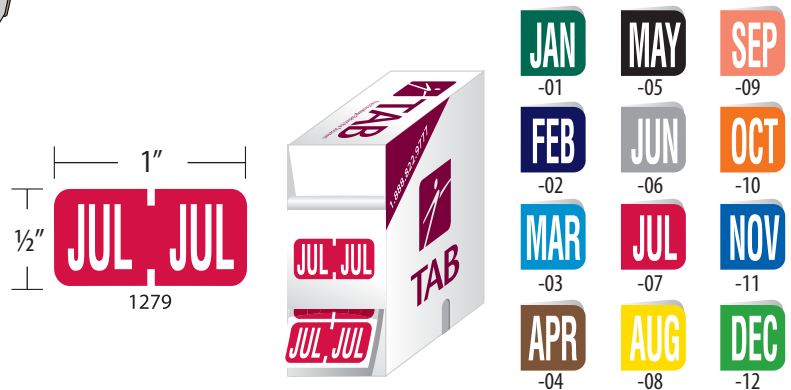

Month Labels

Model	Description	Box Wt.	Labels/Box Box/Set
1279-**-	½" High Month Label (replace ** with number of month desired)	2.3 oz.	1,000
1279-50	½" High Month Label	3 lbs.	12/set



6085-00



6085-75

Barcodes – Self Adhesive Labels

Model	Description	Dimension	Weight per M
6085-00	Item Barcode	½" x 2"	1
6086-00	Location Barcode	½" x 2"	1
6085-75	Item Barcode	¼" x 2¾"	1
6089-75	Item Barcode	1" x 3"	1

*Note: Barcodes can also be factory printed directly onto a folder, or printed on a color-coded strip label. Contact us for more information.

Out Guides

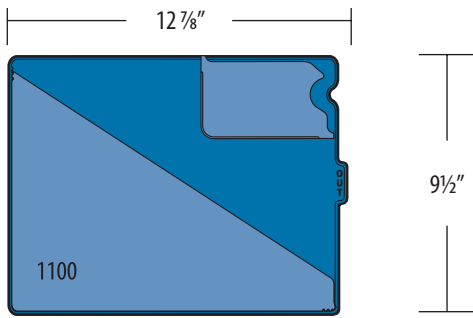

Letter (replace ** With Color)

Model	Description	Carton Wt.	Packed Box/Carton
1100-**	Middle Tab	31 lbs.	50/250

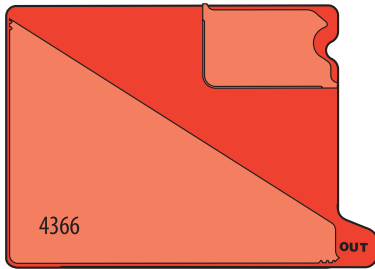

Letter (replace ** With Color)

Model	Description	Carton Wt.	Packed Box/Carton
4366-**	Lower Tab	30 lbs.	50/250

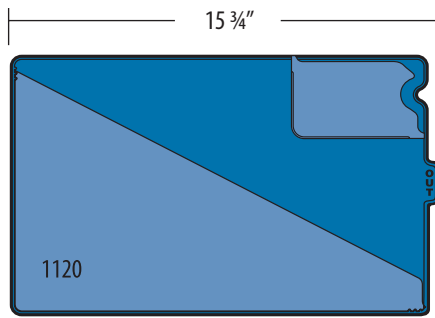

Legal (replace ** With Color)

Model	Description	Carton Wt.	Packed Box/Carton
1120-**	Middle Tab	39 lbs.	50/250

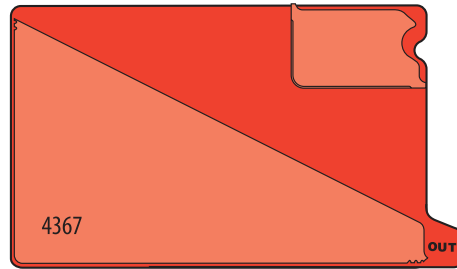

Legal (replace ** With Color)

Model	Description	Carton Wt.	Packed Box/Carton
4367-**	Lower Tab	38 lbs.	50/250

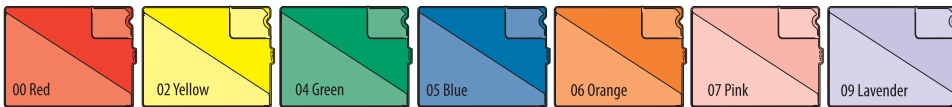

Vinyl Out Guides

Prevent lost files, lost information and search time by using out guides to identify folders removed from the system. Use a charge out slip to identify who has the file. Included is space to file trailing documents, allowing effective interfiling when the folder returns to file. Eliminate stacks of documents at your records desk to be filed.

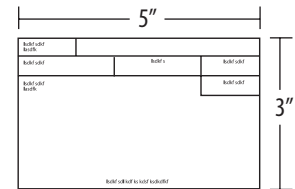

Charge-Out Slips

Model	Description	Carton Wt.	Packed Box/Carton
4368-00	Charge-Out Slips	20 lbs.	1,000

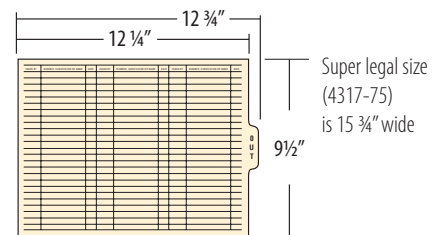

18 pt. Manila Out Card

Model	Description	Carton Wt.	Packed Box/Carton
4308-75	left center tab	35 lbs.	100/500
4317-75	super legal center tab	45 lbs.	100/500

Colorvue Guides

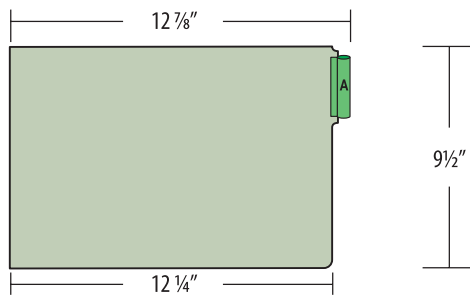

Letter

Model	Description	Set Weight
1261-30	Colorvue w/A-Z inserts Set (25)	5 lbs.
1262-30	Colorvue w/A-Z inserts Set (50)	9 lbs.
1263-30	Colorvue w/A-Z inserts Set (75)	13 lbs.
1264-30	Colorvue w/A-Z inserts Set (100)	17 lbs.

Model	Description	Carton Wt.	Packed Box/Carton
4305-**	Colorvue Guide w/ blank inserts (replace ** With Color)	45 lbs.	25/125

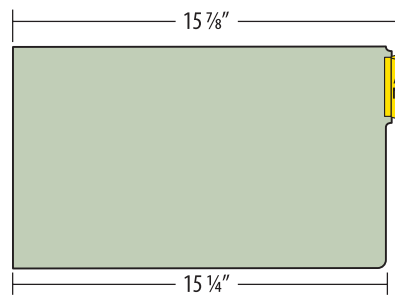

Legal

Model	Description	Set Weight
1261-70	Colorvue w/A-Z inserts Set (25)	5 lbs.
1262-70	Colorvue w/A-Z inserts Set (50)	9 lbs.
1263-70	Colorvue w/A-Z inserts Set (75)	13 lbs.
1264-70	Colorvue w/A-Z inserts Set (100)	17 lbs.

Model	Description	Carton Wt.	Packed Box/Carton
4306-**	Colorvue Guide w/ blank inserts (replace ** With Color)	53 lbs.	25/125

Additional Inserts for Colorvue Guides

Model	Description	Carton Wt.	Packed Box/Carton
4300-01	Colorvue Blank Insert	1 lb.	100
1361-01	Colorvue Alpha Set (25)	1 lb.	100
1362-01	Colorvue Alpha Set (50)	1 lb.	100

Model	Description	Carton Wt.	Packed Box/Carton
1363-01	Colorvue Alpha Set (75)	1 lb.	100
1364-01	Colorvue Alpha Set (100)	1 lb.	100

1262-30 with A-Z inserts

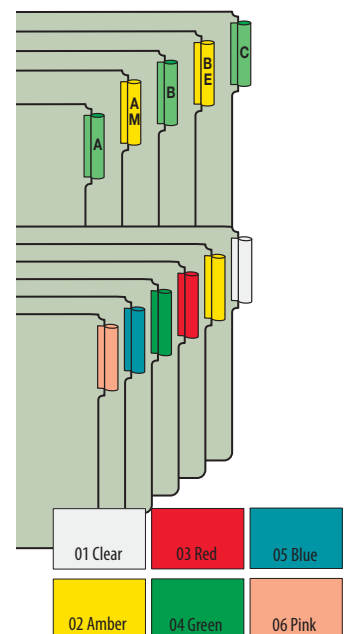

4305-** & 4306-** colors



Top Tab Folders

Top Tab Folders

More than meets the eye

Bring Tab's organization expertise to your top tab filing solutions. Quality folders, Color Coding and System Accessories all designed with Tab's high quality built in.

Top Tab Manila Folders

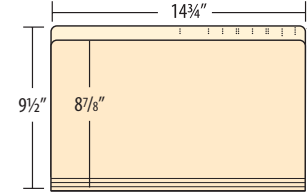
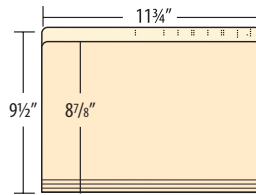
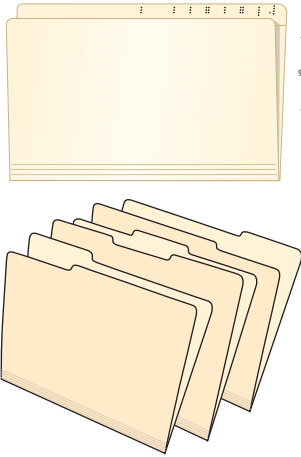

Letter

Model	Description	Carton Wt.	Packed Box/Carton
1112-00	11 pt Double Ply	41 lbs.	100/500
1111-00	14 pt Single Ply	50 lbs.	100/500

Legal

Model	Description	Carton Wt.	Packed Box/Carton
1122-00	11 pt Double Ply	26 lbs.	50/250
1114-00	14 pt Single Ply	32 lbs.	50/250

Letter

Model	Description	Carton Wt.	Packed Box/Carton
1157-00	11 pt Single Ply Positions 123 collated	41 lbs.	100/500
1157-L	11 pt Single Ply Left Tab	41 lbs.	100/500
1157-R	11 pt Single Ply Right Tab	41 lbs.	100/500
1157-C	11 pt Single Ply Center Tab	41 lbs.	100/500

Legal

Model	Description	Carton Wt.	Packed Box/Carton
1158-00	11 pt Single Ply Positions 123 collated	41 lbs.	100/500
1158-L	11 pt Single Ply Left Tab	41 lbs.	100/500
1158-R	11 pt Single Ply Right Tab	41 lbs.	100/500
1158-C	11 pt Single Ply Center Tab	41 lbs.	100/500

Top Tab Solid Color Folders



Letter

Model	Description	Carton Wt.	Packed Box/Carton
1212-**	11 pt Double Ply Solid Color	41 lbs.	100/500
1222-**	14 pt Single Ply Solid Color	26 lbs.	50/250

Legal

Model	Description	Carton Wt.	Packed Box/Carton
1211-**	11 pt Double Ply Solid Color	50 lbs.	100/500
1214-**	14 pt Single Ply Solid Color	32 lbs.	50/250

Replace ** with a color number



Top Tab Pressboard and Classification Folders

Green/Grey and Color Folders w/ Dividers

All folders with 1 & 2 dividers have 2" expansion. Fasteners included on folder and dividers.

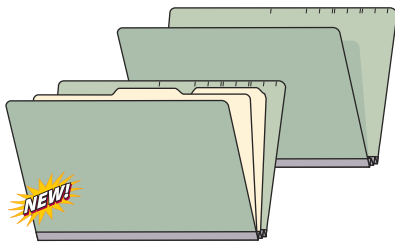

Letter (8 7/8" high front; 9 1/2" high back x 11 3/4" wide)

Model	Description	Carton Wt.	Packed Box/Carton
1255-00	25 pt Green/Grey 2" Expansion	32 lbs.	25/125
1255-**	20 pt Color 2" Expansion	32 lbs.	25/125

Legal (8 7/8" high front; 9 1/2" high back x 14 3/4" wide)

Model	Description	Carton Wt.	Packed Box/Carton
1257-00	25 pt Green/Grey 2" Expansion	40 lbs.	25/125
1257-**	20 pt Color 2" Expansion	40 lbs.	25/125

Letter (8 7/8" high front; 9 1/2" high back x 11 3/4" wide)

Model	Description	Carton Wt.	Packed Box/Carton
1254-00B	25 pt Green/Grey 1 Divider	32 lbs.	25/100
1254-**B	20 pt Color 1 Divider	32 lbs.	25/100
1454-00B	25 pt Green/Grey 2 Dividers	46 lbs.	25/100
1454-**B	20 pt Color 2 Dividers	46 lbs.	25/100

Legal (8 7/8" high front; 9 1/2" high back x 14 3/4" wide)

Model	Description	Carton Wt.	Packed Box/Carton
1256-00B	25 pt Green/Grey 1 Divider	41 lbs.	25/100
1256-**B	20 pt Color 1 Divider	41 lbs.	25/100
1456-00B	25 pt Green/Grey 2 Dividers	47 lbs.	25/100
1456-**B	20 pt Color 2 Dividers	47 lbs.	25/100

Replace ** with a color number



Colors -02 Blue, -05 Canary, -08 Executive Red and -20 Palm Green readily available in letter size. All other colors and any legal size color pressboard folders may require up to a 35-day lead time.

Top Tab Expansion Pockets

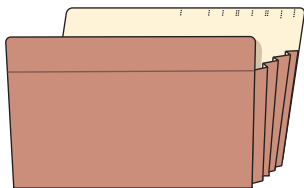

22 pt. Red Rope, Gusset height 6 1/2"

Letter (9" high front; 9 1/2" high back x 11 3/4" wide)

Model	Description	Carton Wt.	Packed Box/Carton
1130-00	1 3/4" Expansion	26 lbs.	20/100
1131-00	3 1/2" Expansion	15 lbs.	10/50

Legal (9" high front; 9 1/2" high back x 14 3/4" wide)

Model	Description	Carton Wt.	Packed Box/Carton
1132-00	1 3/4" Expansion	31 lbs.	20/100
1133-00	3 1/2" Expansion	18 lbs.	10/50

Top TAB Labels / Guides



Alphabetic

Instantly recognize files on a shelf or a desk with these self-adhesive labels. Available in boxes of 500

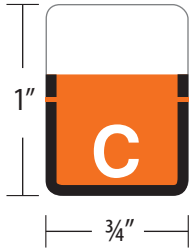

Numeric Labels

Social Security Numbers, Account Numbers, Credit Cards, Zip Codes invoice number, dates can all be identified with these self adhesive numeric color coding labels. Available in boxes of 500

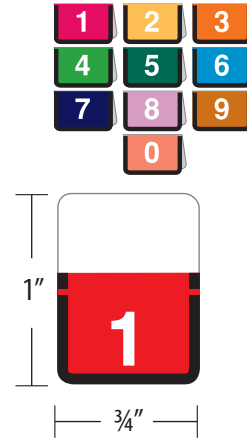

Top Tab Alphabetic Labels

Alphacode – Replace * with desired letter A-Z

Model	Description	Box Wt.	Label/Box Box/Set
1307-*	1" High Alphabetic Color Label	1.3 oz.	500
1307-50	1" High Alphabetic Color Label Complete Set A-Z	4 lbs.	26/set

Top Tab Numeric Labels

Numeric – Replace ** with desired number 0 - 9

Model	Description	Box Wt.	Label/Box Set/Carton
1306-**	1" High Numeric Color Label	2.6 oz.	50 Labels/Box
1306-50	1" High Numeric Color Label Complete Set 0-9	2 lbs.	10 Sets/Carton

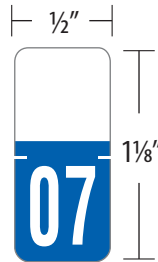

Top Tab Year Code Labels

Year Code – Replace ** with desired year code

Model	Description	Box Wt.	Box/Carton
1308-**	1 1/8" High 2 Digit Year Code	2.3 oz.	50 Boxes/Carton

Out Guides

Prevent lost files, lost information and search time by using out guides to identify folders removed from the system. Use a charge out slip to identify who has the file. Included is space to file trailing documents, allowing effective interfiling when the folder returns to file. Eliminate stacks of documents at your records desk to be filed.

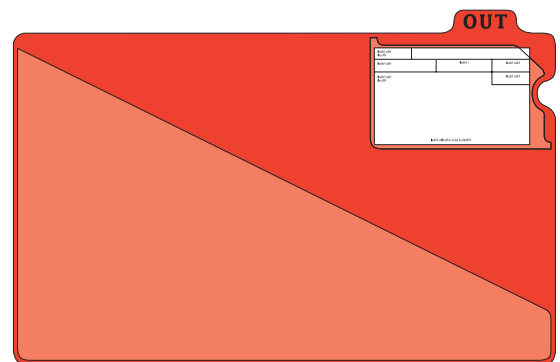
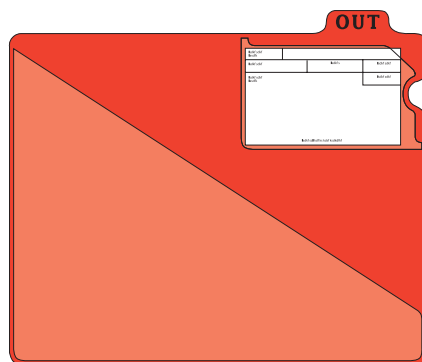

Letter 10" High x 11 3/4" Wide

Model	Description	Carton Wt.	Packed/Carton
4370-00	Out Guide	30 lbs.	50/250
4368-00	Charge Out Slips (3" x 5")	20 lbs.	1,000

Legal 10" High x 14 3/4" Wide

Model	Description	Carton Wt.	Packed/Carton
4388-00	Out Guide	37 lbs.	50/250



TAB is pleased to announce the TAB FORTIfile™ Family of file Products with eternafile™

The complete family of colored file products (file folders, pressed files, pressed classification files, and expansion pockets) let you recognize files at a glance. FORTIfile folders provide the most durability for your everyday filing requirements. TAB FORTIfile folders are fully coated with eternafile. Eternafile is an environmentally friendly protective coating that is applied over the entire folder's outer surface, increasing the strength and rigidity of every TAB FORTIfile product.

Features

- Faster Retrieval by Segmenting Groups of Files by Color
- Environmentally Friendly
- Highly Durable
- Write on, Erase, and Reuse
- Customization Available
- Entire FORTIfile line available in all 7 colors

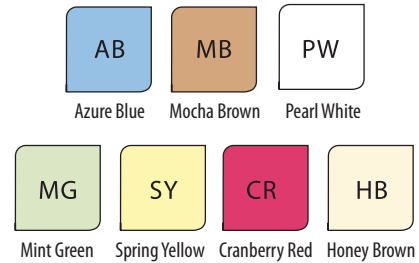

FORTIfile™ - Folders

FORTIfile folders have a full, double reinforced side tab. FORTIfile folders are available in letter and legal sizes.

Model #	Description	Dimensions	Weight / M	Packed Box/Carton
FF4219-**	13.5 pt. Letter Fortifile	9 1/2" x 12 1/4"	112	50/250
FF4229-**	13.5 pt. Legal Fortifile	9 1/2" x 15 1/4"	136	50/250

To add fasteners, please specify fastener type and position when ordering

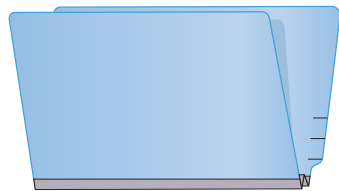

FORTIfile™ - Pressed Files

FORTIfile pressed files are the answer for heavy duty filing applications and expand to 2".

Model #	Description	Dimensions	Weight / M	Packed Box/Carton
FF4712-**13	31 pt. 2" Expansion, letter	9 1/2" x 12 1/4"	207	20/100
FF4722-**13	31 pt. 2" Expansion, legal	9 1/2" x 15 1/4"	80	20/100

*2" bonded fasteners included in positions #1 and #3



FORTIfile™ - Pressed Classification Folders

FORTIfile classification folders have built in dividers to segment information within a highly durable folder and have 2" or 3" expansion capabilities.

Model #	Description	Dimensions	Weight / M	Packed Box/Carton
FF4012-**13	31 pt. 2" Exp, letter, 1 div	9 1/2" x 12 1/4"	290	20/100
FF4013-**13	31 pt. 3" Exp, letter, 2 div	9 1/2" x 12 1/4"	379	20/100
FF4022-**13	31 pt. 2" Exp, legal, 1 div	9 1/2" x 15 1/4"	379	20/100
FF4023-**13	31 pt. 3" Exp, legal, 2 div	9 1/2" x 15 1/4"	461	20/100

*2" bonded fasteners included in positions #1 and #3 of folder and in positions #1 and #3 of each divider.

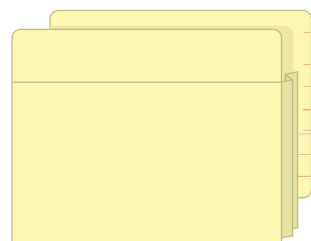

FORTIfile™ - Expansion Pockets

FORTIfile high quality expansion file pockets offer maximum filing capacity for storage of bulky documents, computer printouts and documents of assorted sizes. Full side tab pockets have Tyvek gussets and can expand to 5".

Model #	Description	Dimensions	Weight / M	Packed Box/Carton
FF4835-**	31 pt. 5" Letter Exp. Pkt	9 1/2" x 12 1/4"	270	10/50
FF4845-**	31 pt. 5" Legal Exp. Pkt	9 1/2" x 15 1/4"	330	10/50

Replace ** with appropriate color suffix for all model numbers.



Pressboard Binders

A great 3-ring binder storage alternative that can be filed within your regular records management system. Made of durable 20 pt pressboard with a full cut side tab on right side of back panel. ½" and 1" sizes available, with expansion up to 1 ¼", reinforced with Tyvek tape. Available immediately in Midnight Blue (-16). Other colors available for quote. Call for pricing and minimums.

(Dimensions - front panel 10"h x 11 ½" w body size; back panel 10"h x 12 ¼" w overall size)

Model	Description	Box Wt.	Box/Carton
M18922-16	½" binder	33 lbs.	25/100
M18595-16	1" binder	35 lbs.	25/100

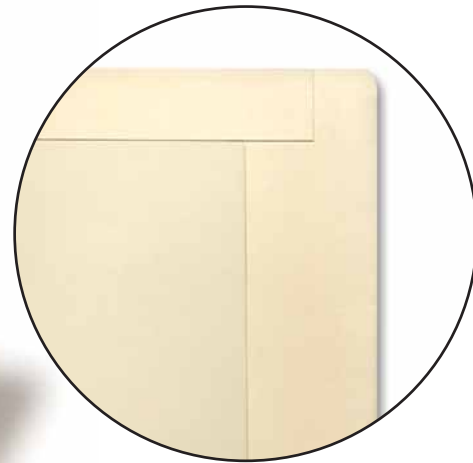

Ames® Match Nested Folders

11 pt. manila folder with 2-ply reinforcement along top horizontal edge on back panel and full cut 2-ply side tab on back panel. Other colors available for quote. Call for pricing and minimums.

(Dimensions 9 ½" h x 11 ⅜" w body size; 9 ½" h x 12 ⅛" w overall size)

Model	Box Wt.	Box/Carton
1342-00	85 lbs.	100/500



TAB

Companion Products

There will always be instances where someone needs products that are not in our regular TAB product line.

The following pages illustrate companion products that are available through TAB Products.

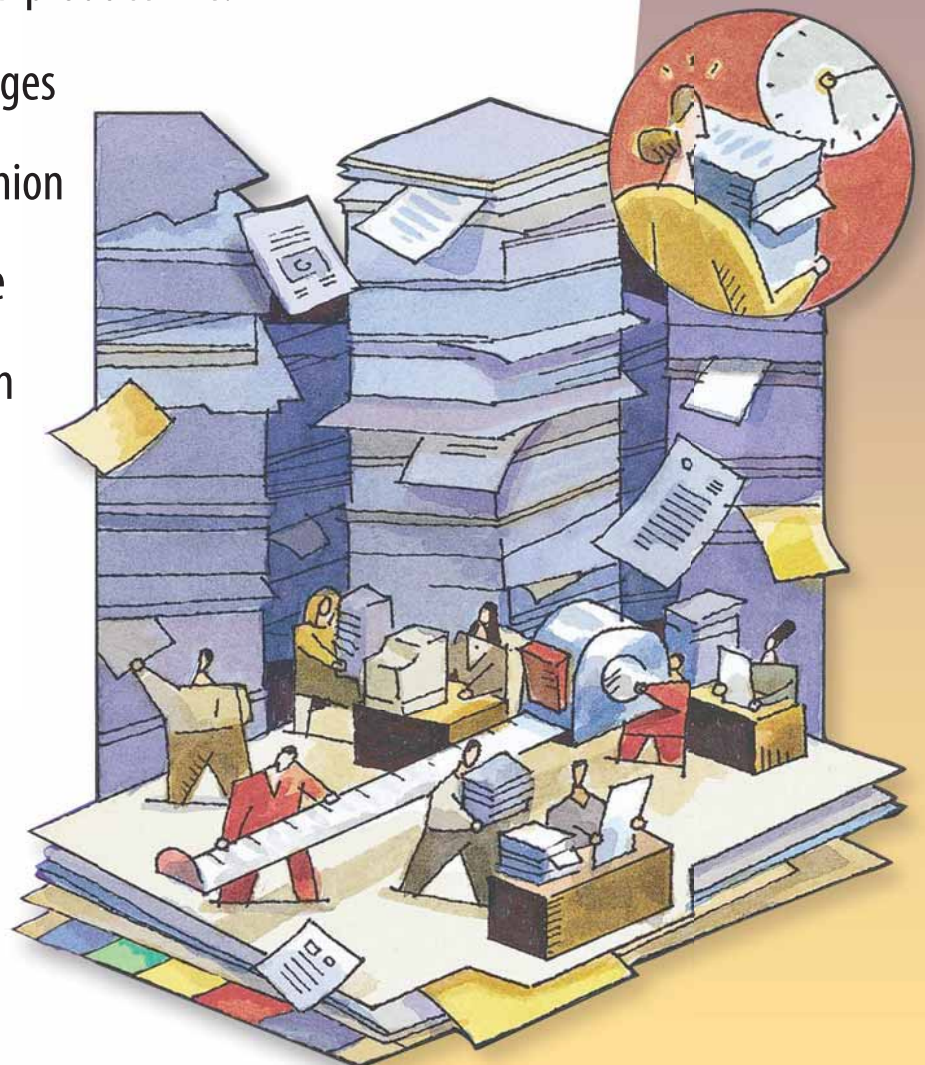



More than meets the eye

Datafile Folders and Pockets uniquely fill the need of our Datafile customer. In 1994 Datafile Canada joined Tab in the US to form the preeminent filing systems company in North America, Australia and Europe. While usage is not as widespread in the US as in Canada, Datafile products continue to be in high demand from Tab.

The Folder of Choice is the most durable folder made – perfect for active filing systems where folders are frequently accessed, retrieved or transferred. Datafile gives you full-cut eternafilem re-inforced tabs. The tab is double thick for rigidity and coated with eternafilem for durability.

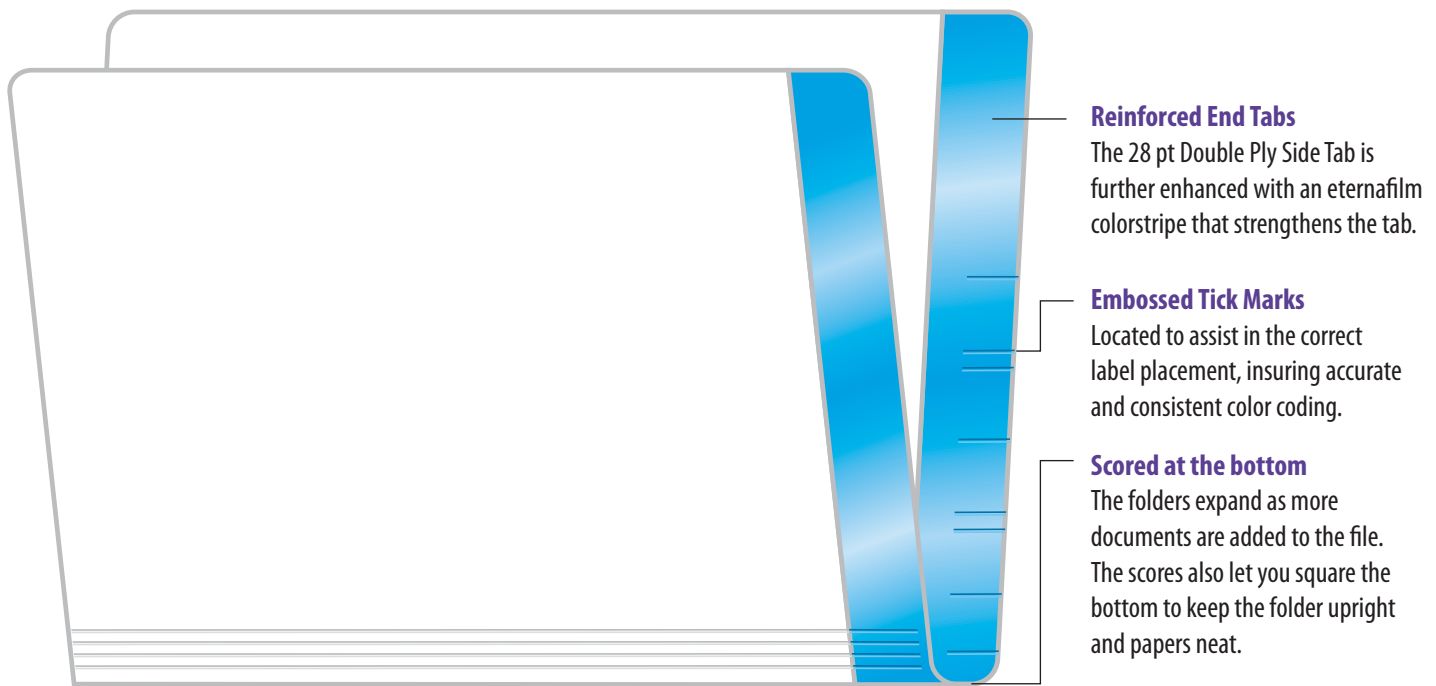

Folder Paper Comparison (Magnification)

Folder Body Thickness	Side Tab Thickness
Datafile Folder of Choice, 14 point	Reinforced with Eternafilem, 31.4 point
Datafile Folder of Choice, 14 point	Without Eternafilem, 28 point
Datafile Economy Folder, 11 point	Without Eternafilem, 22 point
Typical Superstore Folder, 9.5 point	Without Eternafilem, 19 point

Datafile® Folders & Pockets



White Folders with Color Side Tabs

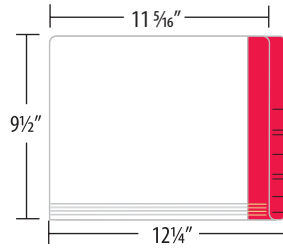
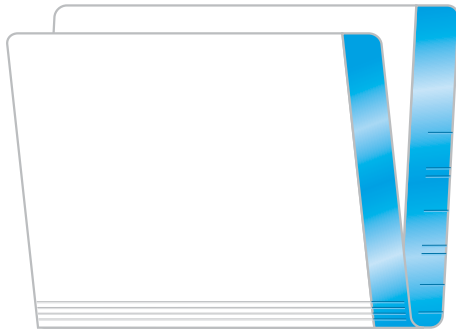

Letter

Model	Description	Carton Wt.	Packed Box/Carton
F1219-*	14pt Eternafilm reinforced	26	50/250
F1259-*	14pt Eternafilm reinforced		

Long letter: 9½ x 12½ x 13 overall

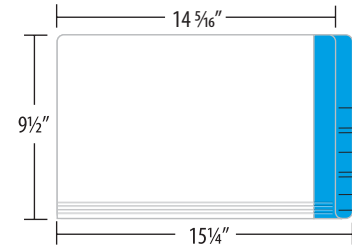

Legal

Model	Description	Carton Wt.	Packed Box/Carton
F1229-*	14pt Eternafilm reinforced	33	50/250



Manila, Taupe, White – Double Side Tab Folders

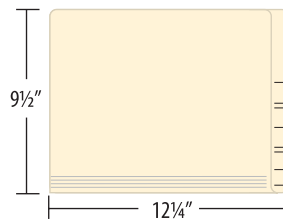

Letter

Model	Description	Carton Wt.	Packed Box/Carton
5260-0T	14pt Taupe, clear eternafilem reinforced	31 lbs.	50/250
5050-0T	11pt Taupe	32 lbs.	50/250
5050-00	11pt Manila	32 lbs.	50/250
F1218	14pt White	26 lbs.	50/250
5150-00	14pt Manila	31 lbs.	50/250

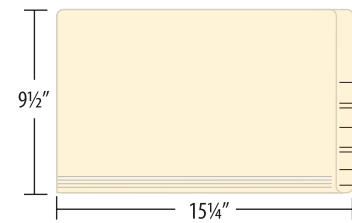

Legal

Model	Description	Carton Wt.	Packed Box/Carton
5100-0T	11pt Taupe	30 lbs.	50/250
5100-00	11pt Manila	30 lbs.	50/250
F1228	14pt White	33 lbs.	50/250

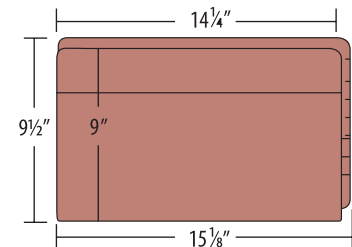
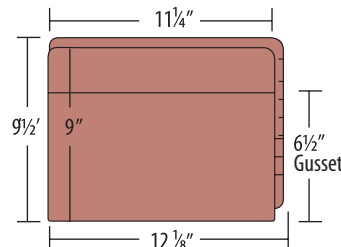

22 pt . Expansion Pockets

Letter

Model	Description	Carton Wt.	Packed Box
F5600	1¾" Expansion Taupe	6 lbs.	50
F5650	3½" Expansion Taupe	6 lbs.	25
F5610	5¼" Expansion Taupe	7 lbs.	25

Legal

Model	Description	Carton Wt.	Packed Box
F5700	1¾" Expansion Taupe	15 lbs.	50
F5750	3½" Expansion Taupe	8 lbs.	25
F5755	5¼" Expansion Red Rope	19 lbs.	10

Expansion Pockets 42pt backs, 28pt Front

Letter

Model	Description	Carton Wt.	Packed Box
F1832	1¾" Expansion Red Rope	16 lbs.	50
F1834	3½" Expansion Red Rope	17 lbs.	50
F1852	1¾" Expansion Red Rope Long Letter 13"W	12 lbs.	50
F1854	3½" Expansion Red Rope Long Letter 13"W	19 lbs.	

Legal

Model	Description	Carton Wt.	Packed Box
F1842	1¾" Expansion Red Rope	18 lbs.	50
F1844	3½" Expansion Red Rope	20 lbs.	50



Datafile® Labels

Alphabetic Labels

Instantly recognize files on a shelf or a desk with these self-adhesive labels.

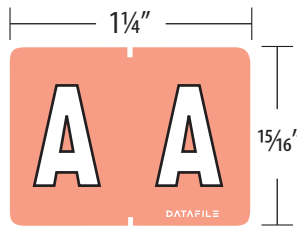

L8720-*



Alphacode – Replace * with desired letter A-Z

Model	Description	Box Wt.	Labels/Box Box/Set
L8720-*	Alphabetic Color Label	3 oz.	500
L8724	Alphabetic Color Label Complete Set – Box	6 lbs.	26

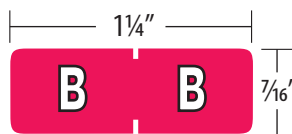

L7701-*

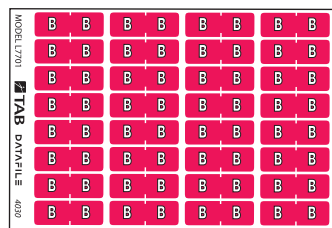

Alphacode – Replace * with desired letter A-Z

Model	Description	Box Wt.	Labels Per Package
L7701-*	Alphabetic Color Label 32 labels/sheet, 8 sheets/package	8 oz.	256



L7600-*

Solid Color Labels

Replace * with desired color number

Model	Description	Box Wt.	Labels Per Box
L7600-*	Solid Color label	3 oz.	500

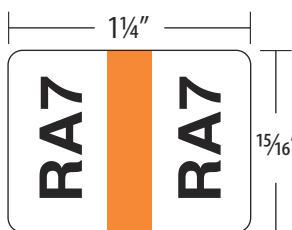
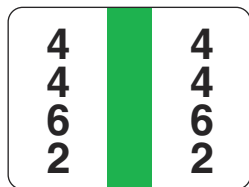

Custom Printed Label

Custom printed strip labels can be printed vertically or horizontally in black ink. When ordering, specify vertical or horizontal and the print copy desired. Maximum digits horizontally is 3 and vertically is 6. 500 labels/box.



Model	Description	Carton Wt.	Packed Box/Carton
DF737-11	Light Blue	.51 lbs.	500
DF737-12	Red	.51 lbs.	500
DF737-13	Yellow	.51 lbs.	500
DF737-16	Purple	.51 lbs.	500
DF737-25	Light Green	.51 lbs.	500
DF737-27	Dark Green	.51 lbs.	500
DF737-31	White	.51 lbs.	500
DF737-58	Brown	.51 lbs.	500
DF737-77	Lavender	.51 lbs.	500
DF737-78	Pink	.51 lbs.	500
DF737-87	Light Orange	.51 lbs.	500
DF737-88	Dark Orange	.51 lbs.	500



Numeric Labels

Social Security Numbers, Account Numbers, Credit Cards, Zip Codes invoice number, and dates can all be identified with these self adhesive numeric color coding labels. Available in boxes of 500.

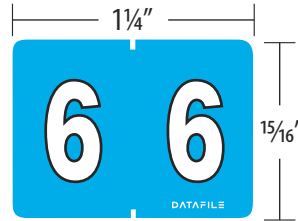
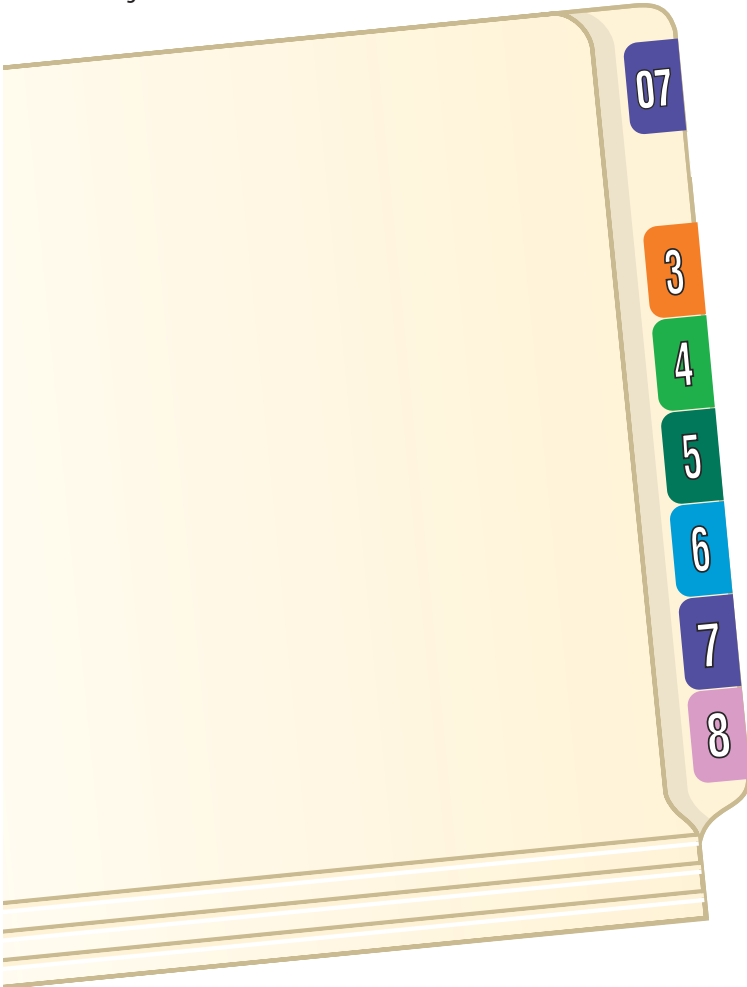

L8700-*



Numeric – Replace * with desired number 0 - 9

Model	Description	Box Wt.	Labels/Box Box/Set
L8700-*	Numeric Color Label	3.9 oz.	500
L8706	Numeric Color Label Complete Set 0-9	4 lbs.	10

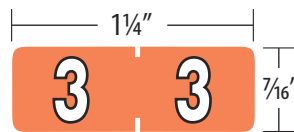

L7700-*



Numeric – Replace * with desired number 0 - 9

Model	Description	Box Wt.	Labels/Box Box/Set
L7700-*	Numeric Color Label	2 oz.	500

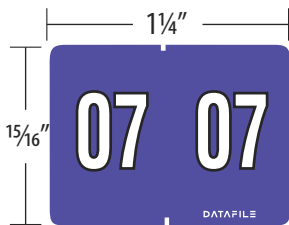

L8800-**

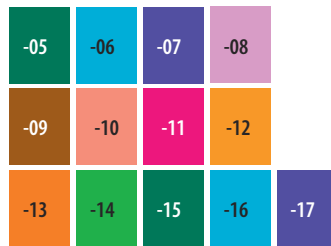

Year Labels – Box

Replace ** with desired year number

Model	Description	Box Wt.	Labels/Box Box/Set
L8800-**	2 Digit Year Labels – 500/box	3.5 oz.	500

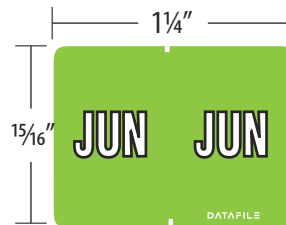

L8801-*



Month Labels – Sheet

Replace ** with desired month number

Model	Description	Box Wt.	Labels Per Package
L8801-*	Month Sheet Labels – 16 labels/sheet, 15 sheets/package	1.5 oz.	240



Medical Labels

ALLERGIC: _____

4406-00

ALLERGIES

4405-00

ALLERGIC TO:

ALLERGY

4407-00 (WA) Wrap Around

ALLERGIC TO:

4414-00

NO KNOWN ALLERGIES

4413-00

ALLERGIES/DRUG REACTIONS

NO KNOWN ALLERGIES

4421-00

**Patient Record
Confidential**

4412-00

CONFIDENTIAL
*For Authorized
Personnel Only*

4411-00

- Medicare
- Medicaid
- BC/BS
- United Healthcare
- Aetna
- Other _____
- Worker Comp.
- Self Pay
- Auto
- Kaiser
- CIGNA

4415-00

**Do Not Release
PATIENT RECORD**

4420-00

**ADVANCE
DIRECTIVE**

Living Will _____
Health Care Proxy _____
Durable Power of Attorney _____
for Health Care _____
Other _____

4425-00

Medical Labels

Model	Description	Labels/Roll	Model	Description	Labels/Roll
4405-00	2" x 2" Allergy	500	4420-00	Do Not Release PI 2¾" x ¾"	300
4406-00	5½" x 1" Allergy	175	4421-00	Allergies/Drug Reactions 3¼" x 1¾"	250
4407-00	3" x 1" Allergy (WA)	500	4425-00	Advanced Directive Fl Green 2½" x 2½"	500
4411-00	4" x 2½" Confidential	100/pkg			
4412-00	4" x 2½" Patient Info	100/pkg			
4413-00	7/8" x 1½" No Known Allergies	250			
4414-00	7/8" x 1½" Allergy	250			
4415-00	3¼" x 1¾" Multi Insurance	250			

Barkley® Competitive Match Labels



Barkley® ABKM Series Alphabetic Labels

Model No.	Description	Box Weight	Labels/Box
4500-A	Alpha A	2.6 oz.	500
4500-B	Alpha B	2.6 oz.	500
4500-C	Alpha C	2.6 oz.	500
4500-D	Alpha D	2.6 oz.	500
4500-E	Alpha E	2.6 oz.	500
4500-F	Alpha F	2.6 oz.	500
4500-G	Alpha G	2.6 oz.	500
4500-H	Alpha H	2.6 oz.	500
4500-I	Alpha I	2.6 oz.	500
4500-J	Alpha J	2.6 oz.	500
4500-K	Alpha K	2.6 oz.	500
4500-L	Alpha L	2.6 oz.	500
4500-M	Alpha M	2.6 oz.	500
4500-N	Alpha N	2.6 oz.	500
4500-O	Alpha O	2.6 oz.	500
4500-P	Alpha P	2.6 oz.	500
4500-Q	Alpha Q	2.6 oz.	500
4500-R	Alpha R	2.6 oz.	500
4500-S	Alpha S	2.6 oz.	500
4500-T	Alpha T	2.6 oz.	500
4500-U	Alpha U	2.6 oz.	500
4500-V	Alpha V	2.6 oz.	500
4500-W	Alpha W	2.6 oz.	500
4500-X	Alpha X	2.6 oz.	500
4500-Y	Alpha Y	2.6 oz.	500
4500-Z	Alpha Z	2.6 oz.	500
4500-Mc	Alpha Mc	2.6 oz.	500

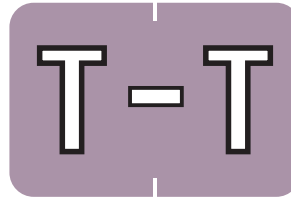

Label size: 1" x 1 1/2"



Barkley® 3/4" Series Year Labels

Label size: 3/4" x 1 1/2"

Model No.	Year	Description	Box Weight	Labels/Box
4502-00	00	Red	2.6 oz.	500
4502-01	01	Pink	2.6 oz.	500
4502-02	02	Yellow	2.6 oz.	500
4502-03	03	Orange	2.6 oz.	500
4502-04	04	Light Green	2.6 oz.	500
4502-05	05	Blue	2.6 oz.	500
4502-06	06	Lilac	2.6 oz.	500
4502-07	07	Brown	2.6 oz.	500
4502-08	08	Gray	2.6 oz.	500
4502-09	09	Gold	2.6 oz.	500



Label size: 1" x 1 1/2"

Barkley® NBKM Series Numeric Labels

Model No.	Description	Box Weight	Labels/Box
4501-00	Numeric 0	2.6 oz.	500
4501-01	Numeric 1	2.6 oz.	500
4501-02	Numeric 2	2.6 oz.	500
4501-03	Numeric 3	2.6 oz.	500
4501-04	Numeric 4	2.6 oz.	500
4501-05	Numeric 5	2.6 oz.	500
4501-06	Numeric 6	2.6 oz.	500
4501-07	Numeric 7	2.6 oz.	500
4501-08	Numeric 8	2.6 oz.	500
4501-09	Numeric 9	2.6 oz.	500



Jeter® Competitive Match Labels

Jeter® Alphabetic Labels

Compatible with 5800 Series

Model No.	Description	Box Weight	Labels/Box
4506-A	A, Orange	2.6 oz.	500
4506-B	B, Dark Green	2.6 oz.	500
4506-C	C, Purple	2.6 oz.	500
4506-D	D, White	2.6 oz.	500
4506-E	E, Light Green	2.6 oz.	500
4506-F	F, Red	2.6 oz.	500
4506-G	G, Light Blue	2.6 oz.	500
4506-H	H, Black	2.6 oz.	500
4506-I	I, Yellow	2.6 oz.	500
4506-J	J, Dark Blue	2.6 oz.	500
4506-K	K, Tan	2.6 oz.	500
4506-L	L, Black	2.6 oz.	500
4506-M	M, Brown	2.6 oz.	500
4506-N	N, Orange	2.6 oz.	500
4506-O	O, Dark Green	2.6 oz.	500
4506-P	P, Purple	2.6 oz.	500
4506-Q	Q, Black	2.6 oz.	500
4506-R	R, Light Green	2.6 oz.	500
4506-S	S, Red	2.6 oz.	500
4506-T	T, Light Blue	2.6 oz.	500
4506-U	U, Black	2.6 oz.	500
4506-V	V, Yellow	2.6 oz.	500
4506-W	W, Dark Blue	2.6 oz.	500
4506-X	X, Tan	2.6 oz.	500
4506-Y	Y, Black	2.6 oz.	500
4506-Z	Z, Brown	2.6 oz.	500

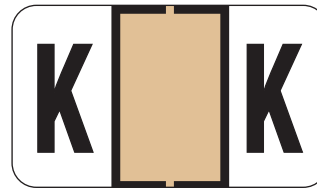

Label size: 1 5/16" x 1 5/8"

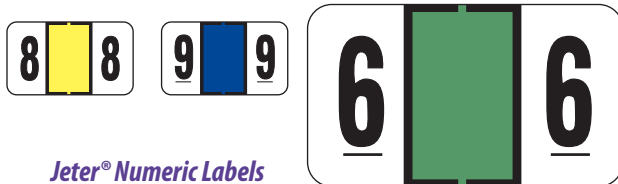

Jeter® Numeric Labels

Compatible with Jeter 7300 Series

Label size: 1 5/16" x 1 5/8"

Model No.	Description	Box Weight	Labels/Box
4507-00	0, Tan	2.6 oz.	500
4507-01	1, Orange	2.6 oz.	500
4507-02	2, Dark Green	2.6 oz.	500
4507-03	3, Purple	2.6 oz.	500
4507-04	4, Light Blue	2.6 oz.	500
4507-05	5, Red	2.6 oz.	500
4507-06	6, Light Green	2.6 oz.	500
4507-07	7, Black	2.6 oz.	500
4507-08	8, Yellow	2.6 oz.	500
4507-09	9, Dark Blue	2.6 oz.	500

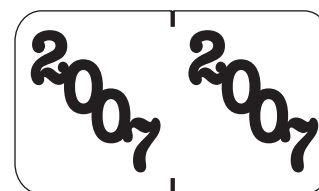

Label size: 3/4" x 1 1/2"

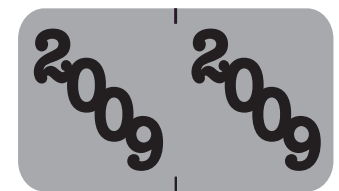

Jeter® Year Labels

Compatible with Jeter 3/4" Vertical

Model No.	Year	Description	Box Weight	Labels/Box
4505-00	2000	Blue	2.6 oz.	500
4505-01	2001	Yellow	2.6 oz.	500
4505-02	2002	Red	2.6 oz.	500
4505-03	2003	Purple	2.6 oz.	500
4505-04	2004	Gold	2.6 oz.	500
4505-05	2005	Black	2.6 oz.	500
4505-06	2006	Orange	2.6 oz.	500
4505-07	2007	White w/Black	2.6 oz.	500
4505-08	2008	Aqua	2.6 oz.	500
4505-09	2009	Gray	2.6 oz.	500

Smead® Competitive Match Labels



Label size: 1" x 1 3/8"

Smead® ACC and ACCS Series Alphabetic Labels

Model No.	Description	Box Weight	Labels/Box
4511-A	Red	2.6 oz.	250
4511-B	Dark Blue	2.6 oz.	250
4511-C	Dark Green	2.6 oz.	250
4511-D	Light Blue	2.6 oz.	250
4511-E	Purple	2.6 oz.	250
4511-F	Orange	2.6 oz.	250
4511-G	Gray	2.6 oz.	250
4511-H	Brown	2.6 oz.	250
4511-I	Pink	2.6 oz.	250
4511-J	Yellow	2.6 oz.	250
4511-K	Tan	2.6 oz.	250
4511-L	Violet	2.6 oz.	250
4511-M	Light Green	2.6 oz.	250
4511-N	Red	2.6 oz.	250
4511-O	Dark Blue	2.6 oz.	250
4511-P	Dark Green	2.6 oz.	250
4511-Q	Light Blue	2.6 oz.	250
4511-R	Purple	2.6 oz.	250
4511-S	Orange	2.6 oz.	250
4511-T	Gray	2.6 oz.	250
4511-U	Brown	2.6 oz.	250
4511-V	Pink	2.6 oz.	250
4511-W	Yellow	2.6 oz.	250
4511-X	Tan	2.6 oz.	250
4511-Y	Violet	2.6 oz.	250
4511-Z	Light Green	2.6 oz.	250



Smead® NCC Vertical/Horizontal Labels

Label size: 1 1/2" x 3 5/8"

Model No.	Description	Pkg. Weight	Labels/Pkg.
4512-AN	A-N Label	2 oz.	100
4512-BO	B-O Label	2 oz.	100
4512-CP	C-P Label	2 oz.	100
4512-DQ	D-Q Label	2 oz.	100
4512-ER	E-R Label	2 oz.	100
4512-FS	F-S Label	2 oz.	100
4512-GT	G-T Label	2 oz.	100
4512-HU	H-U Label	2 oz.	100
4512-IV	I-V Label	2 oz.	100
4512JW	J-W Label	2 oz.	100
4512-KX	K-X Label	2 oz.	100
4512-LY	L-Y Label	2 oz.	100
4512-MZ	M-Z Label	2 oz.	100



Smead® Year Labels

Label size: 1" x 1 1/2"

Model No.	Year	Description	Box Weight	Labels/Box
4510-00	00	Yellow	1.5 oz.	500
4510-01	01	Light Blue	1.5 oz.	500
4510-02	02	Pink	1.5 oz.	500
4510-03	03	Purple	1.5 oz.	500
4510-04	04	Orange	1.5 oz.	500
4510-05	05	Brown	1.5 oz.	500
4510-06	06	Green	1.5 oz.	500
4510-07	07	Gray	1.5 oz.	500
4510-08	08	Red	1.5 oz.	500
4510-09	09	Black	1.5 oz.	500

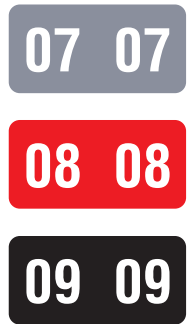

Smead® LCC Numeric and Solid Labels

Label size: 1" x 2"

Model No.	Description	Box Weight	Labels/Box
4509-00	0, Yellow	2.6 oz.	250
4509-01	1, Light Blue	2.6 oz.	250
4509-02	2, Pink	2.6 oz.	250
4509-03	3, Purple	2.6 oz.	250
4509-04	4, Orange	2.6 oz.	250
4509-05	5, Brown	2.6 oz.	250
4509-06	6, Green	2.6 oz.	250
4509-07	7, Gray	2.6 oz.	250
4509-08	8, Red	2.6 oz.	250
4509-09	9, Black	2.6 oz.	250
1116-00	Solid Yellow	2.6 oz.	250
1116-01	Solid Light Blue	2.6 oz.	250
1116-02	Solid Pink	2.6 oz.	250
1116-03	Solid Purple	2.6 oz.	250
1116-04	Solid Orange	2.6 oz.	250
1116-05	Solid Brown	2.6 oz.	250
1116-06	Solid Green	2.6 oz.	250
1116-07	Solid Gray	2.6 oz.	250
1116-08	Solid Red	2.6 oz.	250
1116-09	Solid Black	2.6 oz.	250
1116-50	Solid Set (00-99)	3.5 lbs.	10 box/set

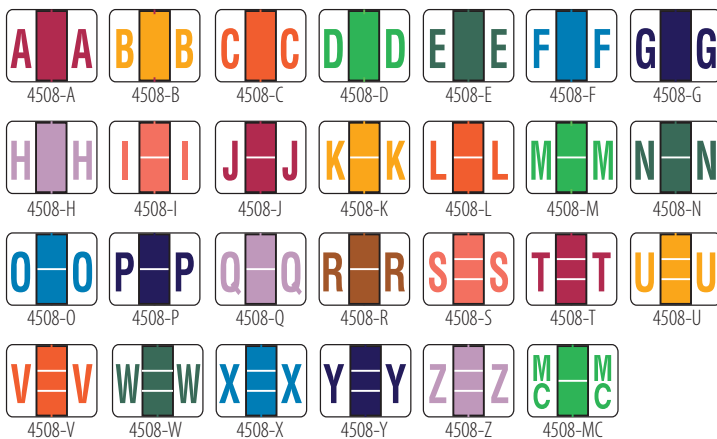
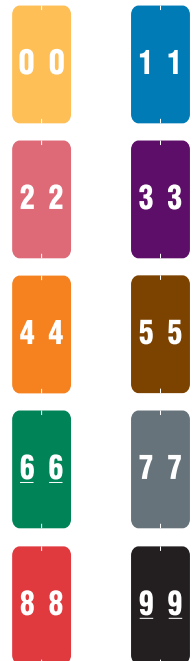

Smead® BCCR Series Alphabetic Labels

Label size: 1" x 1 1/4"

Model No.	Description	Box Weight	Labels/Box
4508-*	Same as 1283-*, only laminated. See above for model #	2.6 oz.	500



Ames® Competitive Match Labels



Label size: 1 7/8" x 1 7/8"



Ames® Numeric Labels

Model No.	Description	Box Weight	Labels/Box
4513-00	0, Red	3 oz.	500
4513-01	1, Gray	3 oz.	500
4513-02	2, Blue	3 oz.	500
4513-03	3, Orange	3 oz.	500
4513-04	4, Purple	3 oz.	500
4513-05	5, Black	3 oz.	500
4513-06	6, Yellow	3 oz.	500
4513-07	7, Brown	3 oz.	500
4513-08	8, Pink	3 oz.	500
4513-09	9, Green	3 oz.	500

Ames® Year Labels

Model No.	Year	Description	Box Weight	Labels/Box
4514-00	00	Red	3 oz.	500
4514-01	01	Gray	3 oz.	500
4514-02	02	Blue	3 oz.	500
4514-03	03	Orange	3 oz.	500
4514-04	04	Purple	3 oz.	500
4514-05	05	Black	3 oz.	500
4514-06	06	Yellow	3 oz.	500
4514-07	07	Brown	3 oz.	500
4514-08	08	Pink	3 oz.	500
4514-09	09	Green	3 oz.	500



Label size: 1 7/8" x 1 7/8"





Model #	Page #	Model #	Page #	Model #	Page #	Model #	Page #	Model #	Page #	Model #	Page #	Model #	Page #	Model #	Page #
1100-***	31	1181-00	11	1282-*	27	4302-DPT	23	4501-05	43	4510-01	45	5260-0T	39	FF4013-***13	34
1102-00	9	1184-**	11	1282-50	27	4305-**	31	4501-06	43	4510-02	45	6085-00	30	FF4022-***13	34
1103-50	9	1187-**	17	1283-**	25	4306-**	31	4501-07	43	4510-03	45	6085-75	30	FF4023-***13	34
1104-00	9	1187-00	17	1283-50	25	4308-75	31	4501-08	43	4510-04	45	6086-00	30	FF4219-**	34
1105-50	9	1189-**	17	1286-**	25	4317-75	31	4501-09	43	4510-05	45	6089-75	30	FF4229-**	34
1106-**	10	1189-00	17	1286-00	25	4333-00	22	4502-00	43	4510-06	45	6301B-PR	29	FF4712-***13	34
1108-00	20	1191-**	17	1287-**	30	4342-00	23	4502-01	43	4510-07	45	6304-00	28	FF4722-***13	34
1108-01	20	1191-00	17	1290-00	25	4343-00	22	4502-02	43	4510-08	45	6304-20	28	FF4835-**	34
1108-02	20	1193-**	17	1303-90	25	4344-00	23	4502-03	43	4510-09	45	6304-40	28	FF4845-**	34
1109-00	23	1193-00	17	1306-**	33	4345-00	23	4502-04	43	4511-A	45	6307-00	28	L7600-*	40
1111-00	32	1194-00	16	1306-50	33	4346-00	16	4502-05	43	4511-B	45	6316-PR	29	L7700-*	41
1112-00	32	1195-00	16	1307-**	33	4347-00	16	4502-06	43	4511-C	45	6321-00	28	L7701-*	40
1114-00	32	1196-00	13	1307-50	33	4348-00	22	4502-07	43	4511-D	45	6321-HA	28	L8700-*	41
1116-00	45	1197-00	13	1308-**	33	4349-00	22	4502-08	43	4511-E	45	6321-HA50	28	L8706	41
1116-01	45	1211-**	32	1309-**	30	4354-50	9	4502-09	43	4511-F	45	6324-00	28	L8720-*	40
1116-02	45	1212-**	32	1317-00	9	4357-13	9	4505-00	44	4511-G	45	6324-HA	28	L8724	40
1116-03	45	1214-**	32	1318-00	9	4358-00	21	4505-01	44	4511-H	45	6324-HA50	28	L8800-**	41
1116-04	45	1222-**	32	1327-00	9	4359-00	21	4505-02	44	4511-I	45	6352-00	28	L8801-**	41
1116-05	45	1235-**	12	1328-00	9	4366-**	31	4505-03	44	4511-J	45	6376-00	28	M18595-16	35
1116-06	45	1235-00	13	1334-**	10	4367-**	31	4505-04	44	4511-K	45	6377-00	28	M18922-16	35
1116-07	45	1236-**	12	1335-**	10	4368-00	31	4505-05	44	4511-L	45	6378-00	28	T1 1001-50	18
1116-08	45	1236-00	13	1336-**	10	4368-00	33	4505-06	44	4511-M	45	6379-00	28	T1 1002-50	18
1116-09	45	1237-00B	13	1337-**	10	4370-00	33	4505-07	44	4511-N	45	6380-00	28	T1 1003-50	18
1116-50	45	1238-00B	13	1342-00	35	4387-**	17	4505-08	44	4511-O	45	6381-00	28	T1 1004-50	18
1118-00	9	1243-**B	15	1344-00	9	4388-00	33	4505-09	44	4511-P	45	6382-00	28	T1 1005-50	18
1119-00	10	1243-00B	15	1345-00	9	4397-**	17	4506-A	44	4511-Q	45	6383-00	28	T1 1006-50	18
1120-**	31	1244-**B	15	1346-00	9	4397-00	16	4506-B	44	4511-R	45	6384-00	28	T1 1007-50	18
1122-00	32	1244-00B	15	1347-00	9	4400-00	30	4506-C	44	4511-S	45	6400-00	28	T1 1008-50	18
1123-00	9	1245-**B	15	1348-**	12	4401-00	30	4506-D	44	4511-T	45	6403-00	28	T1 2001-50	18
1126-**	10	1245-00B	15	1348-00	13	4404-00	23	4506-E	44	4511-U	45	6404-00	28	T1 2002-50	18
1127-00	9	1246-**B	15	1349-**	12	4405-00	42	4506-F	44	4511-V	45	6405-00	28	T1 2003-50	18
1128-00	9	1246-00B	15	1349-00	13	4406-00	42	4506-G	44	4511-W	45	6406-00	28	T1 2004-50	18
1129-00	10	1247-**B	15	1350-**	12	4407-00	42	4506-H	44	4511-X	45	6408-00	28	T1 2005-50	18
1130-00	32	1247-00B	15	1350-00	13	4411-00	42	4506-I	44	4511-Y	45	6409-00	28	T1 2006-50	18
1131-00	32	1248-**B	15	1351-**	12	4412-00	42	4506-J	44	4511-Z	45	6410-00	28	T1 2007-50	18
1132-00	32	1248-00B	15	1351-00	13	4413-00	42	4506-K	44	4512-AN	45	6411-00	28	T1 2008-50	18
1133-00	32	1249-00B	13	1352-**B	15	4414-00	42	4506-L	44	4512-BO	45	6412-00	28	T1 3001-50	18
1139-00	11	1250-**	12	1352-00B	15	4415-00	42	4506-M	44	4512-CP	45	6413-00	28	T1 3002-50	18
1141-00	9	1250-00	13	1352-00B	15	4420-00	42	4506-N	44	4512-DQ	45	6414-00	28	T1 3003-50	18
1142-00	9	1251-**	12	1353-**B	15	4421-00	42	4506-O	44	4512-ER	45	6701DF-N	29	T1 3004-50	18
1147-00	16	1251-00	13	1353-00B	15	4425-00	42	4506-P	44	4512-FS	45	6701DF-S	29	T1 3005-50	18
1149-00	20	1252-00B	13	1354-**B	15	4500-A	43	4506-Q	44	4512-GT	45	70001	20	T1 3006-50	18
1156-00	16	1254-00B	13	1354-00B	15	4500-B	43	4506-R	44	4512-HU	45	70002	20	T1 3007-50	18
1157-00	32	1254-**B	32	1355-**B	15	4500-C	43	4506-S	44	4512-IV	45	70003	20	T1 3008-50	18
1157-C	32	1254-00B	32	1355-00B	15	4500-D	43	4506-T	44	4512-JW	45	70004	20	T1 4001-50	18
1157-L	32	1255-**	32	1356-**	17	4500-E	43	4506-U	44	4512-KX	45	70010	20	T1 4002-50	18
1157-R	32	1255-00	32	1357-**	17	4500-F	43	4506-V	44	4512-LY	45	DF737-11	40	T1 4003-50	18
1158-00	32	1256-**B	32	1361-01	31	4500-G	43	4506-W	44	4512-MZ	45	DF737-12	40	T1 4004-50	18
1158-C	32	1256-00B	32	1362-01	31	4500-H	43	4506-X	44	4513-00	46	DF737-13	40	T1 4005-50	18
1158-L	32	1257-**	32	1363-01	31	4500-I	43	4506-Y	44	4513-01	46	DF737-16	40	T1 4006-50	18
1158-R	32	1257-00	32	1364-01	31	4500-J	43	4506-Z	44	4513-02	46	DF737-25	40	T1 4007-50	18
1159-00	21	1258-00B	15	1378-**	17	4500-K	43	4507-00	44	4513-03	46	DF737-27	40	T1 4008-50	18
1160-00	21	1259-00B	15	1379-**	17	4500-L	43	4507-01	44	4513-04	46	DF737-31	40	T1 5001-50	18
1161-00	21	1261-30	31	1380-**	17	4500-M	43	4507-02	44	4513-05	46	DF737-58	40	T1 5002-50	18
1162-**	10	1261-70	31	1381-**	17	4500-Mc	43	4507-03	44	4513-06	46	DF737-77	40	T1 5003-50	18
1163-**	10	1262-30	31	1385-00	16	4500-N	43	4507-04	44	4513-07	46	DF737-78	40	T1 5004-50	18
1164-00	36	1262-70	31	1387-00	16	4500-O	43	4507-05	44	4513-08	46	DF737-87	40	T1 5005-50	18
1166-**	11	1263-30	31	1389-00	25	4500-P	43	4507-06	44	4513-09	46	DF737-88	40	T1 5006-50	18
1168-00	11	1263-70	31	1390-00	25	4500-Q	43	4507-07	44	4514-00	46	F1218	39	T1 5007-50	18
1169-00	11	1264-30	31	1394-00	25	4500-R	43	4507-08	44	4514-01	46	F1219-*	39	T1 5008-50	18
1170-50	36	1264-70	31	1396-00	25	4500-S	43	4507-09	44	4514-02	46	F1228	39	T1 6001-50	18
1171-50	36	1274-DBL	30	1397-00	25	4500-T	43	4508-*	45	4514-03	46	F1229-*	39	T1 6002-50	18
1172-**	11	1274-SGL	30	1398-00	25	4500-U	43	4509-00	45	4514-04	46	F1832	39	T1 6003-50	18
1174-**	11	1277-*	27	1401-00	25	4500-V	43	4509-01	45	4514-05	46	F1834	39	T1 6004-50	18
1175-00	11	1277-50	27	1406-**	10	4500-W	43	4509-02	45	4514-06	46	F1842	39	T1 6005-50	18
1176-00	11	1278-**	25	1426-**	10	4500-X	43	4509-03	45	4514-07	46	F1844	39	T1 6006-50	18
1177-00	36	1278-50	25	1454-**B	32	4500-Y	43	4509-04	45	4514-08	46	F5600	39	T1 6007-50	18
1177-25	36	1279-**	30	1454-00B	32	4500-Z	43	4509-05	45	4514-09	46	F5610	39	T1 6008-50	18
1177-50	36	1279-50	30	1456-**B	32	4501-00	43	4509-06	45	5050-00	39	F5650	39		
1177-75	36	1280-*	27	1456-00B	32	4501-01	43	4509-07	45	5050-0T	39	F5700	39		
1178-00	11	1280-50	27	4300-01	31	4501-02	43	4509-08	45	5100-00	39	F5750	39		
1179-00	11	1281-**	27	4302-01	23	4501-03	43	4509-09	45	5100-0T	39	F5755	39		
1180-00	11	1281-50	27	4302-50	23	4501-04	43	4510-00	45	5150-00	39	FF4012-***13	34		



Order On-Line

Now you can easily order TAB Express products online. Simply go to www.tab.com and click **Shop Online**.

SEARCH:
 advanced search

Home
 File Accessories
 Folders
 Labels
 Pockets
 Tabquik Labels

Welcome to Tab Express Online Ordering!

With over fifty years experience and a global presence, TAB can help you organize, access and manage your critical documents and records. Whether you need file folders, office storage, or a strategy for compliance, we've got you covered.

TAB can provide customized, tiered solutions to match your exact document management needs. From records management consulting and file room outsourcing to shredding and archiving, our experts will get you where you want to be. And with our extensive range of filing systems and products, we can provide you with everything you need, including colour-coded filing systems, custom labels and file folders, high density cabinets, mobile shelving, and file management software.

NEED HELP? If you need assistance or can't find what you are looking for, please give us a call at **1-888-822-9777**. We can answer your questions over the phone or arrange for a local representative to contact you.

Home | Terms of Use | Customer Service | My Account | Checkout
 All Rights Reserved © 2006 Tab.com

TAB My Account Supplies Storage Systems Technology Checkout
 0 Items in Cart Total: \$0.00

SEARCH:
 advanced search

Home
 File Accessories
 Folders
 Labels
 Pockets
 Tabquik Labels

Supplies

The Accessories
 Folders
 Labels
 Pockets
 Tabquik Labels

TAB My Account Supplies Storage Systems Technology Checkout
 0 Items in Cart Total: \$0.00

SEARCH:
 advanced search

Home
 File Accessories
 Folders
 Labels
 Pockets
 Tabquik Labels

Folders

1 2 3 4 5 6 7 8 9 10 11 12 13 14 15 16 17 18 19 20 21 22 23 24 25 26 27 28 29 30 31 32 33 34 35 36 37 38 39 40 41 42 43 44 45 46 47 48 49 50 51 52 53 54 55 56 57 58 59 60 61 62 63 64 65 66 67 68 69 70 71 72 73 74 75 76 77 78 79 80 81 82 83 84 85 86 87 88 89 90 91 92 93 94 95 96 97 98 99 100

156L
 Color Folder, Double Ply Size Tab - 11 at Standard, Legal (100 folders)
 Replaces ** with appropriate color suite
 \$45.14
 Color:
 Buy:
 Add To Cart
 Add To Wish List
 Email To A Friend

156C
 Color Folder, Double Ply Size Tab - 11 at Standard, Letter (100 folders)
 Replaces ** with appropriate color suite
 \$38.99
 Color:
 Buy:
 Add To Cart
 Add To Wish List
 Email To A Friend

TAB My Account Supplies Storage Systems Technology Checkout
 0 Items in Cart Total: \$0.00

SEARCH:
 advanced search

Home
 File Accessories
 Folders
 Labels
 Pockets
 Tabquik Labels

Labels

1 2 3 4 5 6 7 8 9 10 11 12 13 14 15 16 17 18 19 20 21 22 23 24 25 26 27 28 29 30 31 32 33 34 35 36 37 38 39 40 41 42 43 44 45 46 47 48 49 50 51 52 53 54 55 56 57 58 59 60 61 62 63 64 65 66 67 68 69 70 71 72 73 74 75 76 77 78 79 80 81 82 83 84 85 86 87 88 89 90 91 92 93 94 95 96 97 98 99 100

157R-20
 Alphanumeric Alphabet Color-Red Labels - 10 High - Complete Set A-Z (500 labels per letter/line)
 Complete Set of 26 Letters
 \$40.75
 Buy:
 Add To Cart
 Add To Wish List
 Email To A Friend

157L-20
 Alphanumeric Alphabet Color-Red Labels - 10 High (100-1000000)
 Replaces ** with associated letter from A-Z
 \$4.00
 Alpha:
 Buy:
 Add To Cart
 Add To Wish List
 Email To A Friend

100-50
 Alphanumeric Alphabet Color-Red Labels - 10 High - Complete Set A-Z (Each set contains 500 labels, complete set of 26 rolls)
 Buy:
 Add To Cart
 Add To Wish List
 Email To A Friend

A-07-FI-SPEC-G
 Rev. 0407



P.O. Box 153
 Mayville, WI 53050

1.888.822.9777
 cspaper@tab.com
 www.tab.com